

# Marshall

## CV620-IP / CV620-IPW

Full HD PTZ Conference IP Camera



## User Manual

# Table of Contents

<b>Chapter 1. Safety Instructions .....</b>	<b>3</b>
<b>Chapter 2. Package Contents .....</b>	<b>5</b>
<b>Chapter 3. Product Overview.....</b>	<b>6</b>
3.1 Overview.....	6
3.2 Description of LED indicator.....	6
<b>Chapter 4. Instruction for installation.....</b>	<b>7</b>
4.1 Preparation before installation.....	7
4.2 Instruction for installation.....	7
4.3 Connecting devices .....	14
<b>Chapter 5. Remote Control and Setting Menu .....</b>	<b>18</b>
5.1 Functions of remote control.....	18
5.2 Setting Menu.....	19
<b>Chapter 6. Descriptions of Major Functions .....</b>	<b>25</b>
6.1 I would like to switch to CV620-IPW.....	25
6.2 I would like to save the current lens position data .....	25
6.3 I would like to clear the saved position data .....	25
6.4 I would like to turn on the back light compensation function .....	25
6.5 I would like to adjust the shooting angle of the lens .....	25
6.6 I would like to zoom in/out images .....	25
6.7 I would like to adjust the focal length .....	25
6.8 I would like to adjust the AF speed.....	25
6.9 I would like to set the image mode .....	26
6.10 I would like to freeze images .....	26
6.11 I would like to rotate the image.....	26
6.12 I would like to change the camera direction.....	26
6.13 I would like to display the current status .....	26
6.14 I would like to reset to the default value.....	26
<b>Chapter 7. Network Function Settings Description.....</b>	<b>27</b>
7.1 Web System Requirements.....	27
7.2 Online IP Camera .....	27
7.3 Web Page Function Description .....	29
<b>Chapter 8. DIP switch setting .....</b>	<b>36</b>
8.1 DIP SWITCH.....	36
8.2 RS-422 Connection .....	37
<b>Chapter 9. Troubleshooting .....</b>	<b>39</b>

# Chapter 1. Safety Instructions

---

Please use the product following the safety instructions below:

## 1 Operation

- 1.1 Please use the product in the recommended operating environment.
- 1.2 Do not place Light Engine in tilted position.
- 1.3 Do not place the product on an unstable trolley, stand or table.
- 1.4 Do not use this product near water or source of heat.
- 1.5 Use attachments only as recommended.
- 1.6 Use the type of power source indicated on the HD Camera. If you are not sure of the type of power available, consult your dealer or local electricity company for advice.
- 1.7 Always take the following precautions when handling the plug. Failure to do so may result in sparks or fire.
  - Ensure the plug is free of dust before inserting it into a socket.
  - Ensure that the plug is inserted into the socket securely.
- 1.8 Do not overload wall sockets, extension cords or multi-way plug boards to avoid potential risks.
- 1.9 Do not block slots and openings in the case of this product as poor ventilation may lead to overheating of this product.
- 1.10 Except as specifically instructed in this User Manual, do not attempt to open or remove covers by yourself. It may expose you to electric shock or other hazards. Refer all servicing to licensed service personnel.
- 1.11 Unplug this product from the wall outlet and refer servicing to licensed service personnel when the following situations happen:
  - If the power cords are damaged or frayed.
  - If liquid is spilled into the HD Camera or the HD Camera has been exposed to rain or water.

## 2 Installation

- 2.1 For security considerations, please make sure the standard hanging rack you bought is in line with UL or CE safety approbations and installed by technician personnel approved by agents.

## 3 Storage

- 3.1 Do not place the HD Camera where the cord can be stepped on as this may result in fraying or damage to the lead or the plug.
- 3.2 Never push objects of any kind through cabinet slots. Never allow liquid of any kind to spill into the HD Camera.
- 3.3 Unplug this product during thunderstorms or if it is not going to be used for an extended period.
- 3.4 Do not place this product or accessories on top of vibrating equipment or heated objects.

## 4 Cleaning

- 4.1 Unplug all the cables before cleaning. Use a damp cloth for cleaning. Do not use liquid or aerosol cleaners.





## 5 Remote control (if the accessories are equipped with remote control)

- 5.1 Using an incorrect battery type in the remote control may result in breakdown. Follow local instructions on how to dispose of used batteries.

### ■ Precautions

**Warning: To reduce the risk of fire or electric shock, do not expose this appliance to rain or moisture.**

If HD Camera will not be used for an extended time, unplug it from the power socket.

	<table border="1"> <tr> <td style="text-align: center;">Note</td> </tr> <tr> <td style="text-align: center;">Risk of Electric Shock Please do not open it by yourself.</td> </tr> </table>	Note	Risk of Electric Shock Please do not open it by yourself.	
Note				
Risk of Electric Shock Please do not open it by yourself.				
<p>Caution: To reduce the risk of electric shock, do not remove cover (or back). No user-serviceable parts inside. Refer servicing to licensed service personnel.</p>				
	<p>This symbol indicates that this equipment may contain dangerous voltage which could cause electric shock.</p>		<p>This symbol indicates that there are important operating and maintenance instructions in this User Manual with this unit.</p>	

**■ FCC Warning**

This HD Camera has been tested and found to comply with the limits for a Class A digital device, pursuant to Article 15-J of FCC Rules. These limits are designed to provide reasonable protection against harmful interference in a commercial installation.

This digital apparatus does not exceed the Class A limits for radio noise emissions from digital apparatus as set out in the interference-causing equipment standard entitled "Digital Apparatus," ICES-003 of Industry Canada.

Cet appareil numérique respecte les limites de bruits radioélectriques applicables aux appareils numériques de Classe A prescrites dans la norme sur le matériel brouilleur: "Appareils Numériques," NMB-003 édictée par l'Industrie.

**■ EN55032 (CE Radiation) Warning**

Operation of this equipment in a residential environment could cause radio interference.

## Chapter 2. Package Contents

---

CV620-IPW

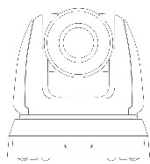

Instruction for installation



Remote Control



Power Cord



Appearance may vary depending on country/region

Power Adapter

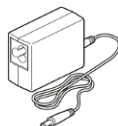

RS-422 Connector

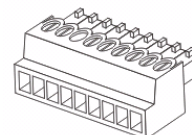

Metal Plate A

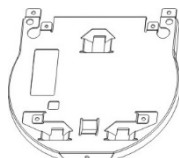

Metal Plate B

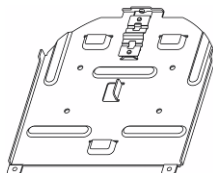

M3 Screws



## Chapter 3. Product Overview

### 3.1 Overview

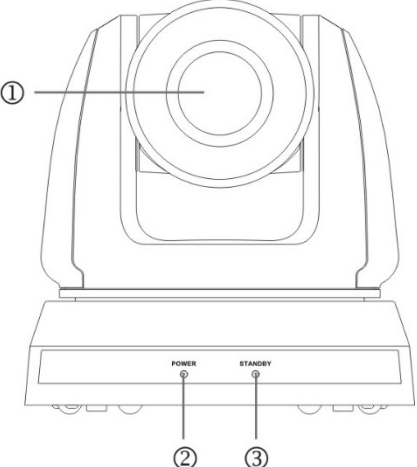
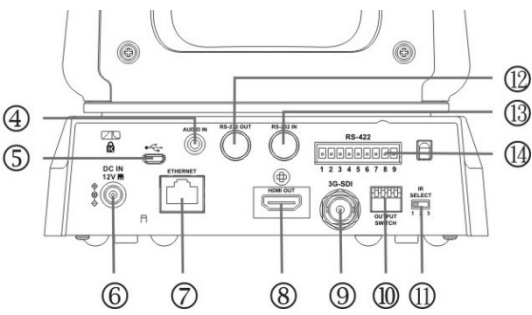
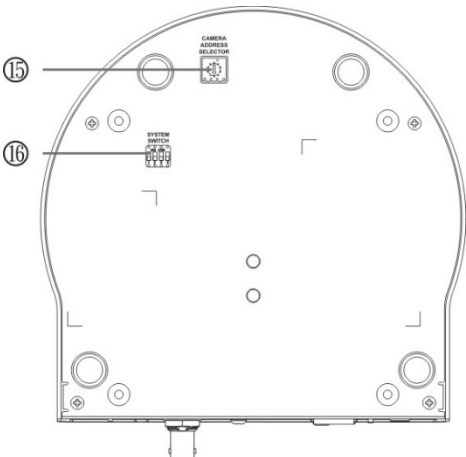
<p>Front View</p> 	<p>1. Camera lens</p> <p>2. Power LED indicator</p> <p>3. Standby LED indicator</p> <p>4. Audio In</p> <p>5. USB port (for FW update)</p>
<p>Back View</p> 	<p>6. Power input</p> <p>7. Network port (supported for PoE)</p> <p>8. HDMI Output</p> <p>9. 3G-SDI</p> <p>10. OUTPUT Switch</p>
<p>Bottom</p> 	<p>11. IR SELECT</p> <p>12. RS-232 output</p> <p>13. RS-232 input</p> <p>14. RS-422 Connection</p> <p>15. Camera Address Selectors</p> <p>16. SYSTEM Switch</p>

### 3.2 Description of LED indicator

Status	Power	Standby
Startup in progress	Green light	Orange light
In use	Green light	No indicator
In standby mode	No indicator	Orange light
Signal from the remote control is received	Green light flickers; it flickers every 0.5 second	No indicator

## Chapter 4. Instruction for installation

### 4.1 Preparation before installation

Installation and connection of CV620-IPW HD camera requires special skills. To install by yourself, please follow necessary steps, ensure steady and tight installation of the device, and pay attention to your safety to avoid any accident.

- 4.1.1 Ensure the safety of the installation environment. Please do not install the device on unstable ceiling or in a place where the device is in danger of falling to avoid any accident.**
- 4.1.2 Please check whether accessories in the box are complete or not. Please contact the supplier for any shortage, and make sure to keep the accessories in the box intact.**
- 4.1.3 Please choose a proper place for installation of CV620-IPW in advance. Please determine an installation place according to the following requirements**
  - 4.1.1.1 Confirm the position for the object to be captured.
  - 4.1.1.2 Confirm whether the CV620-IPW is set at a proper distance from other light sources.

### 4.2 Instruction for installation

#### 4.2.1 I would like to install CV620-IPW on the desk

##### 4.2.1.1 Precautions for installation

- ◆ Please install the machine on a flat desk
- ◆ Do not grab the camera head by hand when handling the device
- ◆ Do not rotate the camera head by hand. Improper rotation may result in breakdown of the camera

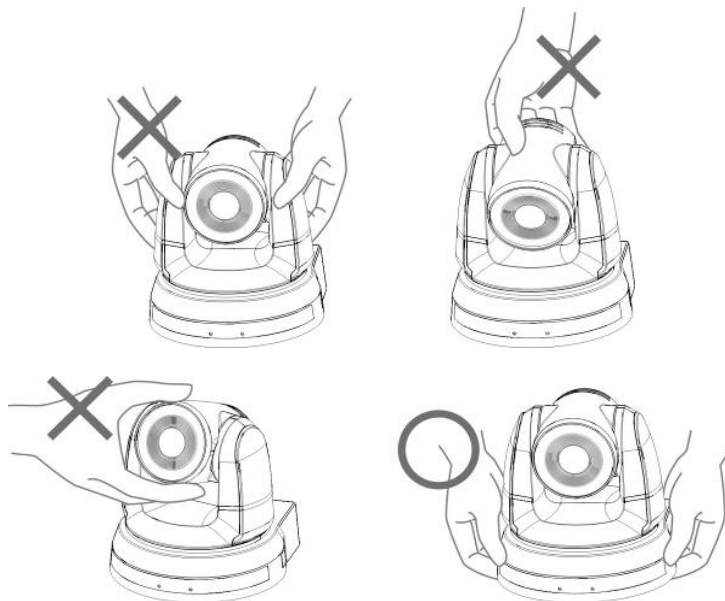

##### 4.2.1.2 Installation steps

1. Please adjust DIP switch at first prior to installation

**Note:** Please refer to [Chapter 8 DIP Switch Setting](#) for the relevant descriptions on DIP switch.

2. Place the camera on a flat desk directly to ensure the normal vertical and horizontal operation of the machine

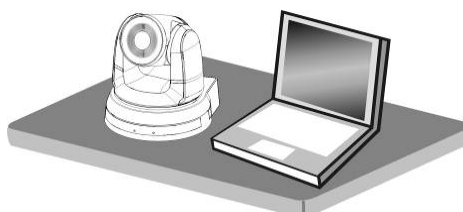

**4.2.2 I would like to install CV620-IPW on the ceiling**

**4.2.2.1 Prepare for the parts and equipment required during the installation**

1. Accessories of CV620-IPW in the box (metal plates A,B, M3 screw silver x 8, black x 2)
2. Screw for locking on ceiling mounted hanger x 4
3. Drilling machine, screw driver, ladder

**4.2.2.2 Camera Size**

Length x Width x Height: 174 x 186.2 x 185.5 mm

Weight: 1.8 Kg

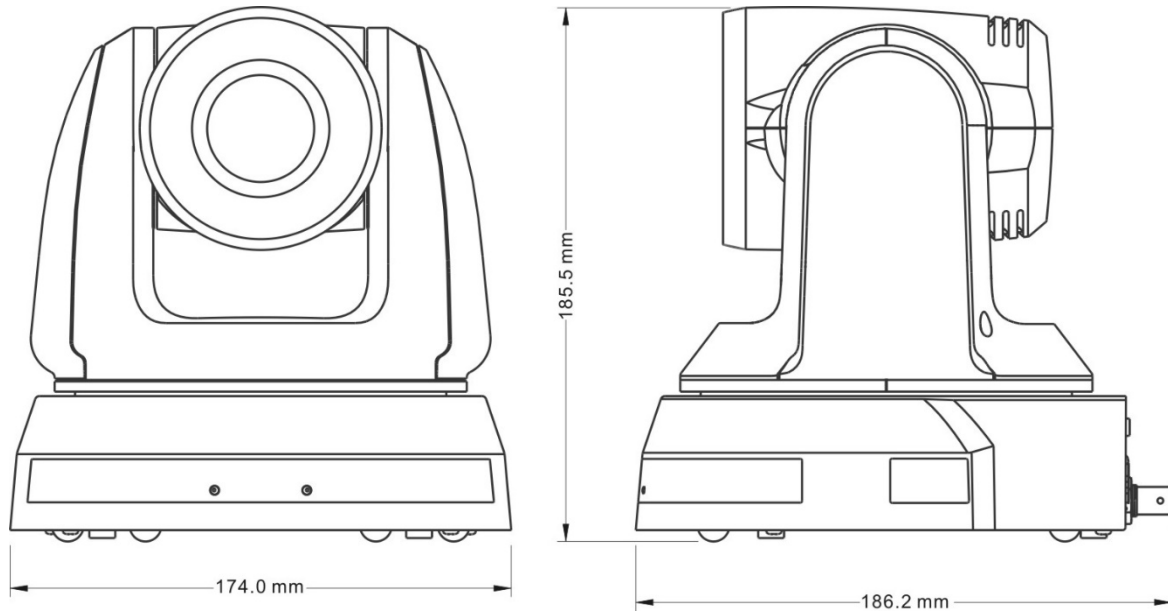

**4.2.2.3 Max. rotation dimension of camera**

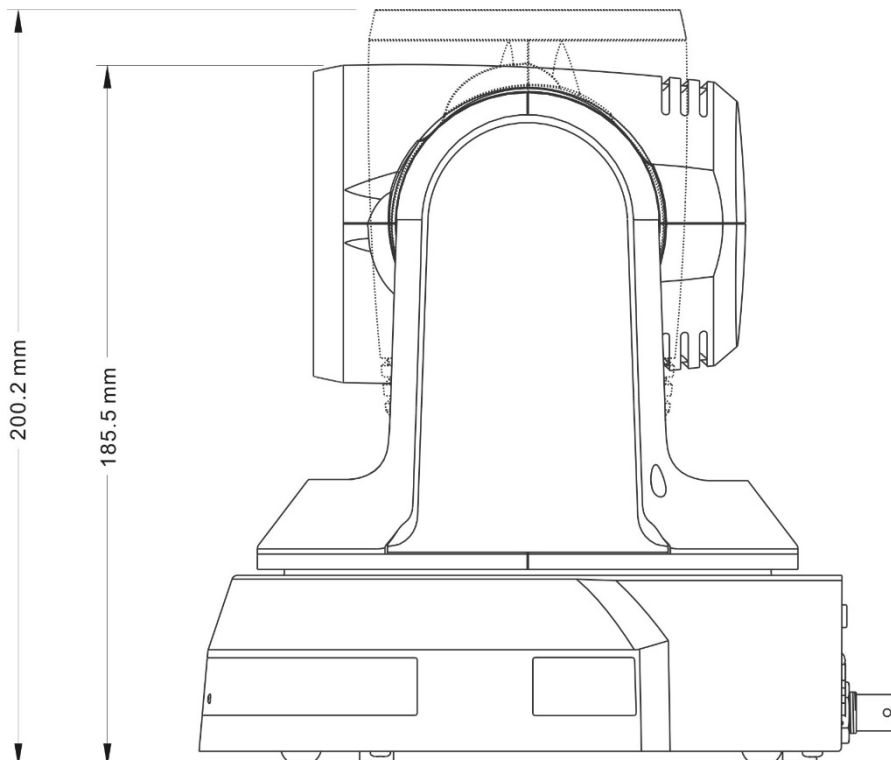



4.2.2.4 Size Diagram

1. Metal plate B - ceiling side

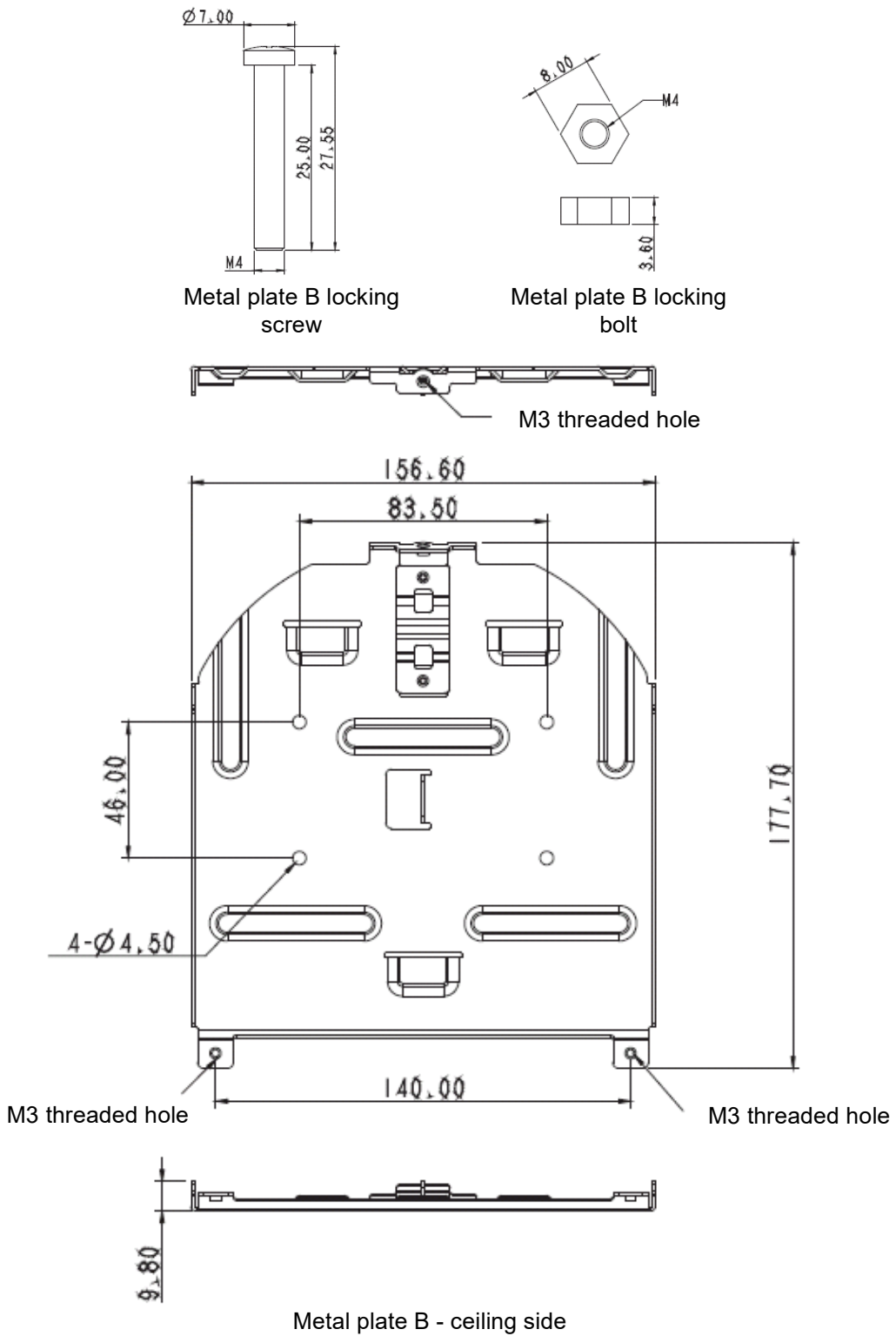

2. Metal plate A - machine side

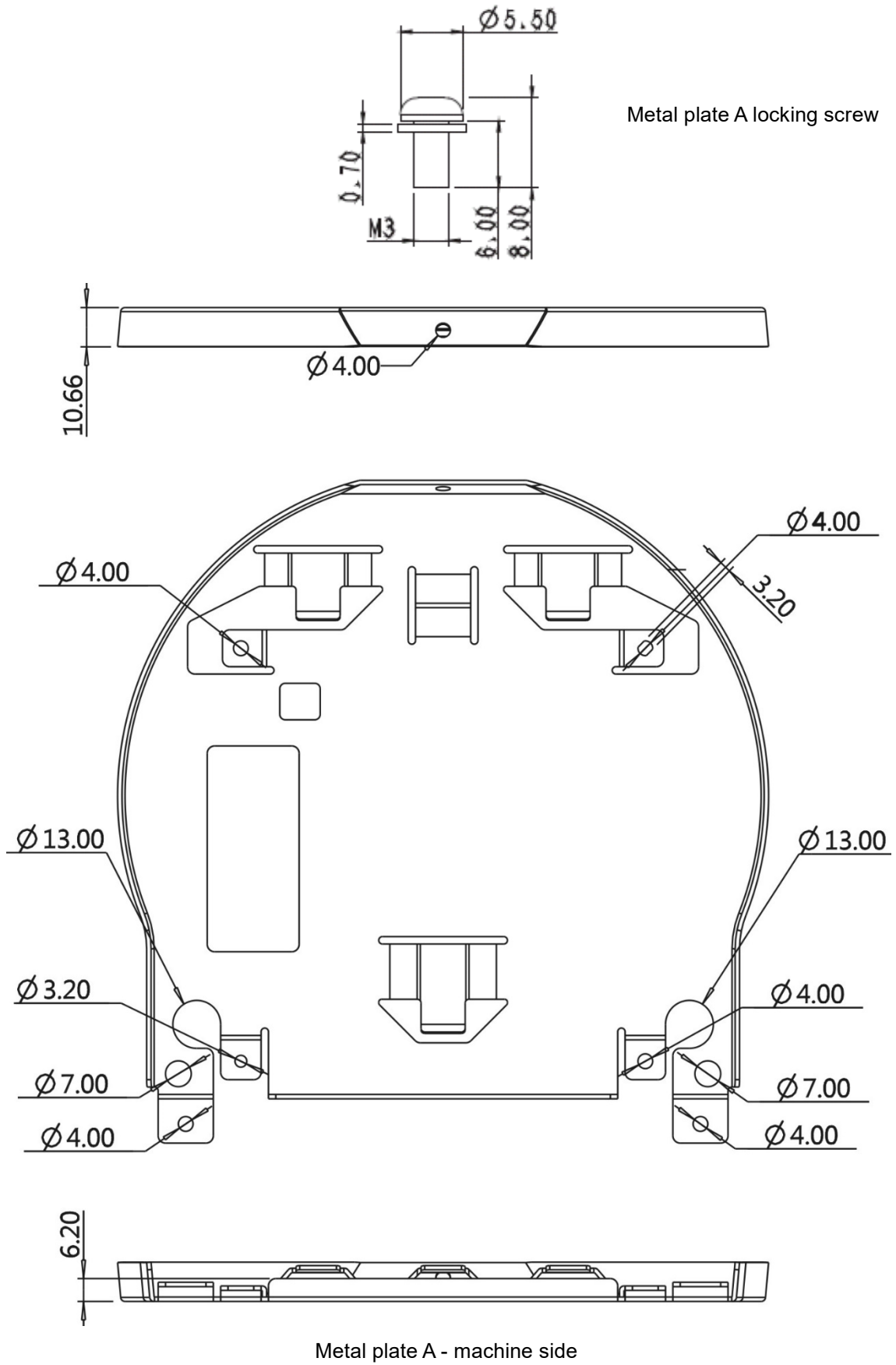

3. Bottom of machine

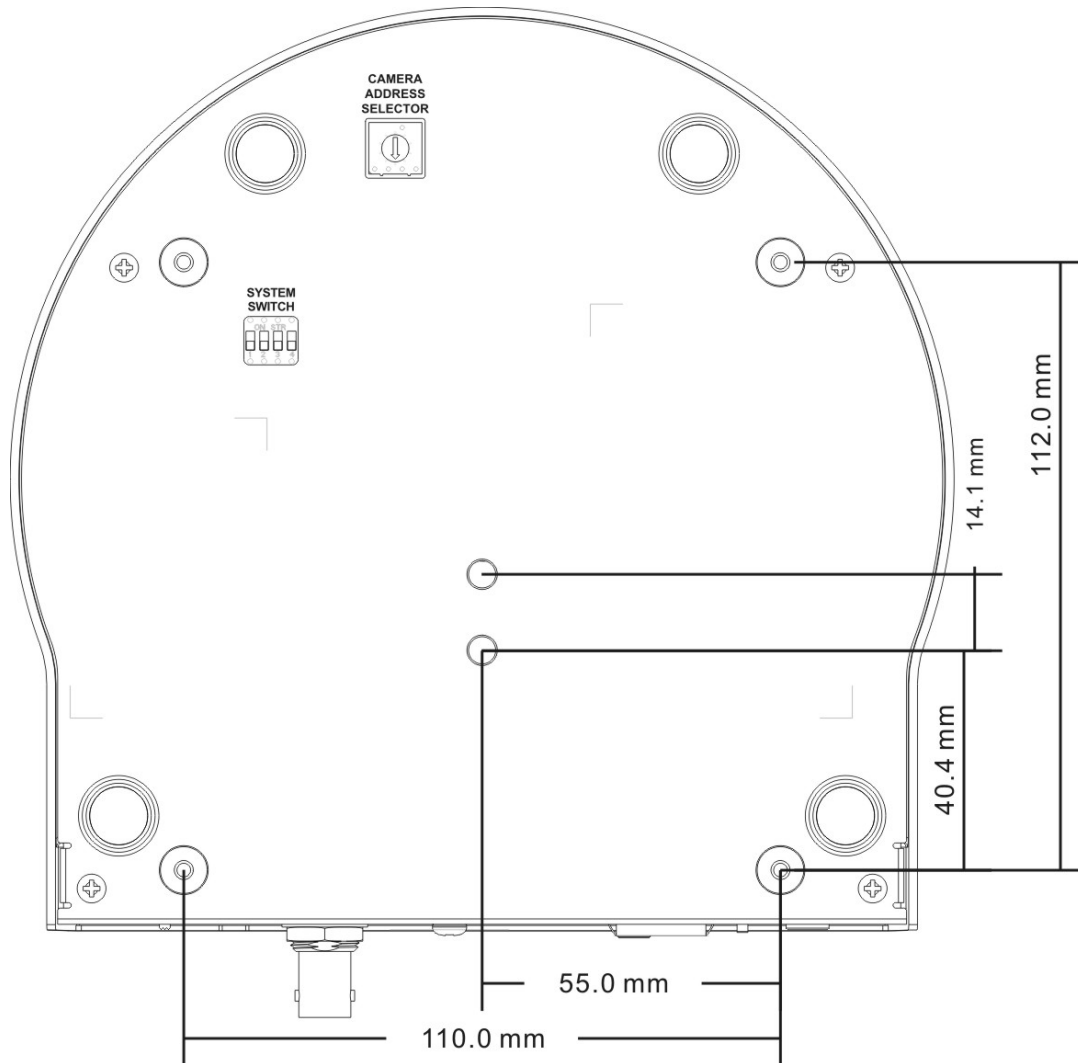

4.2.2.5 Precautions for installation

1. Before installation, please confirm the orientation of the machine relative to the object to be captured
2. It is recommended that the machine should be set at a distance of more than 1 meter away from the object to be captured. Please adjust for a best distance according to the magnification of the lens

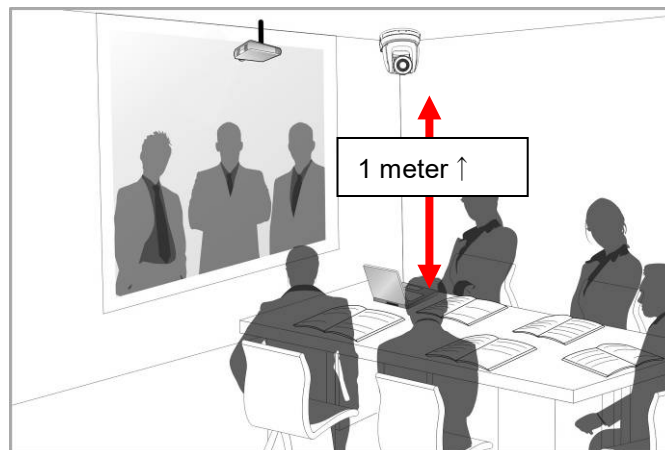

3. The machine (including metal plates) is weighed at about 2.5 kg. If it is to be installed on the ceiling, please use the hanger that has obtained UL security approval to prevent the machine from falling.

4. Please check whether the camera is installed securely on a regular basis

#### 4.2.2.6 Installation steps

1. Please adjust resolution on DIP switch at first

**Note:** Please refer to [Chapter 8. DIP Switch Setting](#) for the relevant descriptions on DIP switch.

2. Fix the metal plate A on the machine base with 4 M3 silver screws

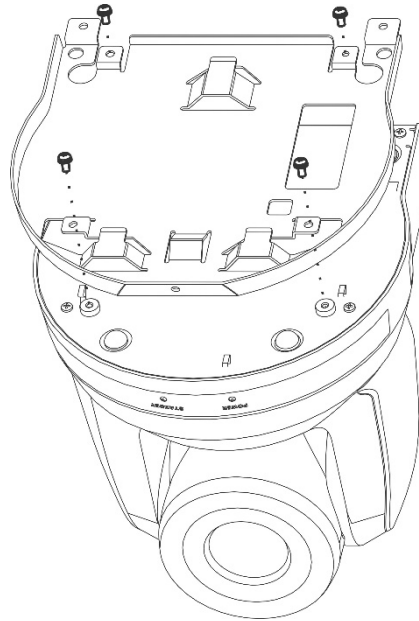

3. Lock the metal plate B on ceiling mounted hanger

※Caution:

- (1) Please use the hanger that has obtained UL security approval
- (2) Please reserve the hole for the connecting wires of the camera

4. Combine the metal plate A and the metal plate B

- (1) Push the metal plate A up to the ceiling and then to the right to latch the metal plate B
- (2) And then secure with 2 M3 silver screws and 1 M3 black screw

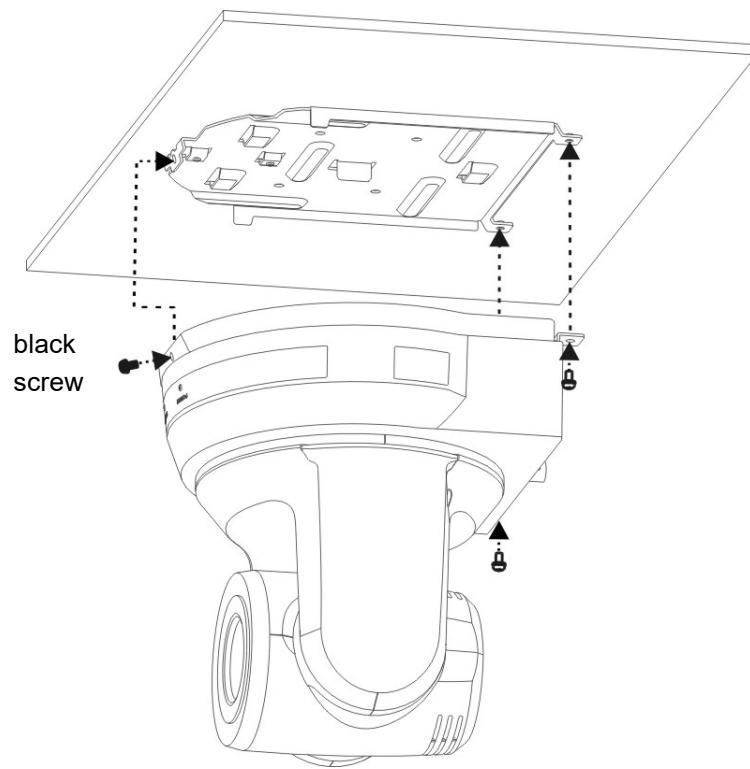

**4.2.2.7 How to remove**

1. Remove the connecting wires from the camera
2. Uninstall the camera together with the ceiling, loosen the three screws that fix the metal plates A and B and push to the left to remove the machine

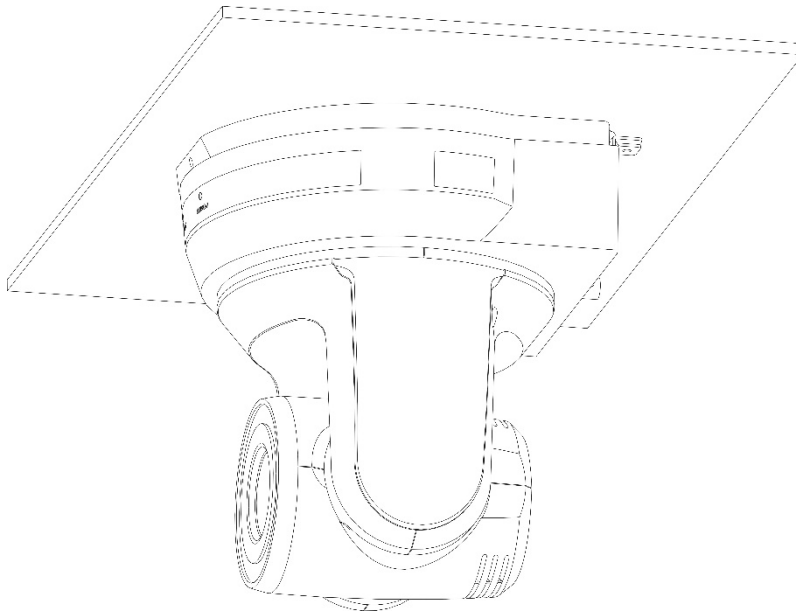

3. Then remove the screws on the hanger and the machine

**4.3 Connecting devices**

**4.3.1 Image Output**

**4.3.1.1 Connecting to PC (video conference)**

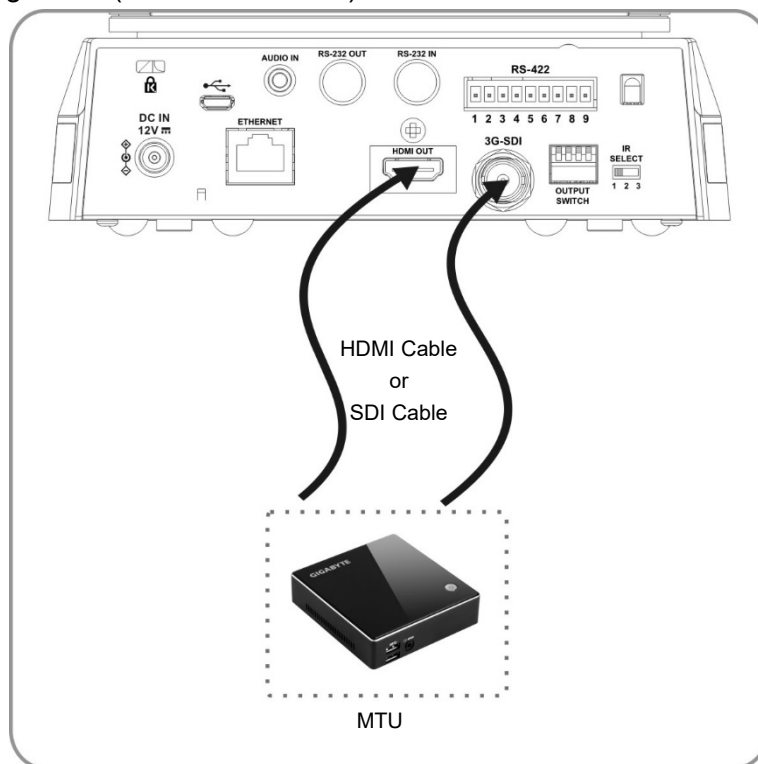

**<Remark 1> SDI supports the audio output of 48 KHz only.**

**4.3.1.2 Connecting to an HDTV/computer monitor (HDMI)**

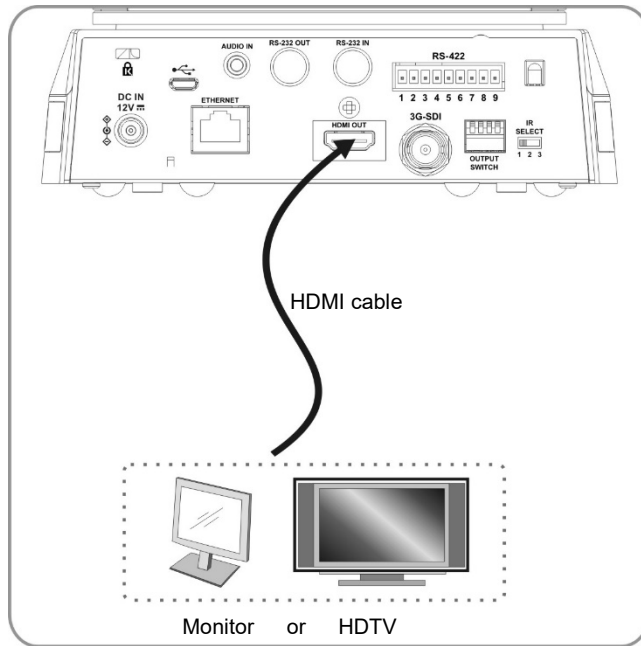

4.3.1.3 Connecting to Internet

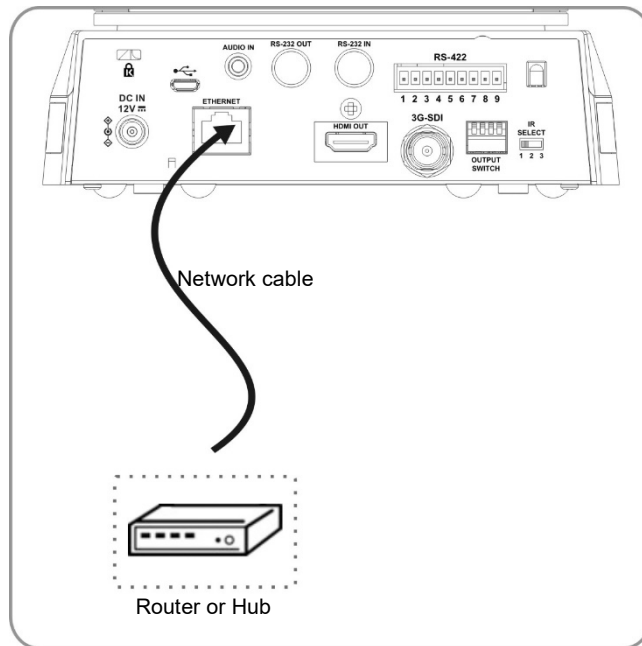

**Note: CV620-IPW can be used with browsers, VLC and QuickTime after it is connected to the Internet.**

4.3.1.4 Connecting AUDIO IN

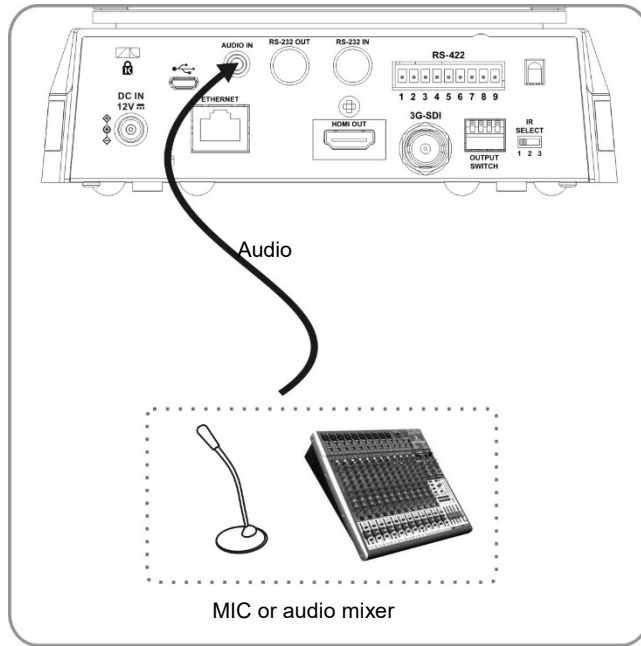

**Note:** Set the [Audio In] in the OSD to reflect the input device

4.3.2 Controlling CV620-IPs with the computer

4.3.2.1 Connecting to one computer for connection between CV620-IPs (RS-232 in/out)

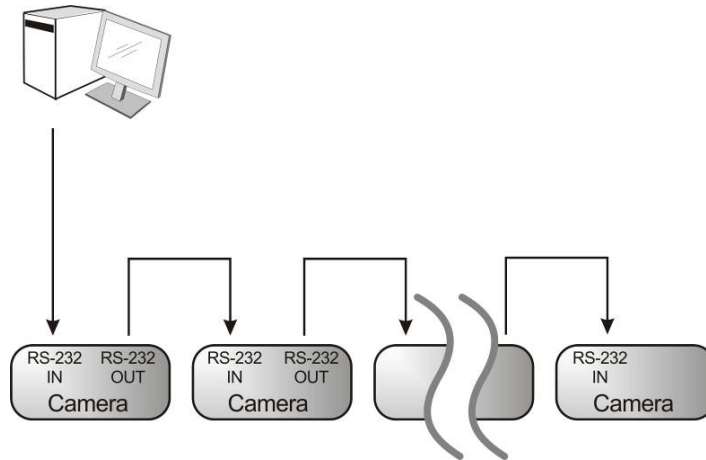

**Note:** With RS-232 in/out, at most 7 CV620-IPs can be connected.

4.3.2.2 Connecting to one computer for connection between CV620-IPs (RS-422)

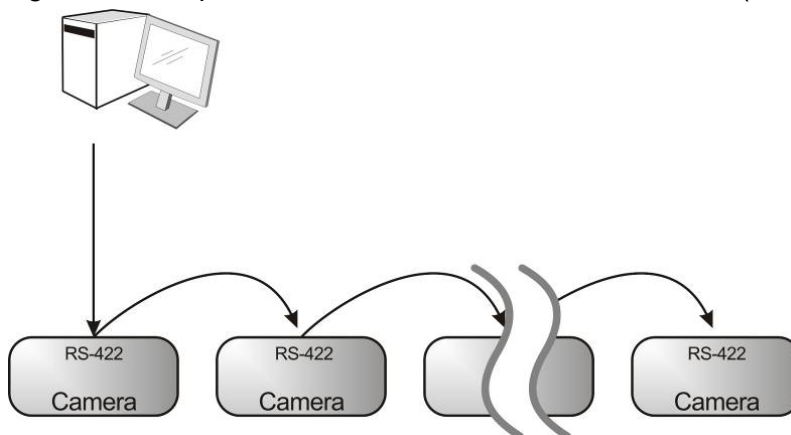

**Note:** Please refer to [8.2 RS-422 connection](#) for the RS-422 connection instructions.



**Note: With RS-422, at most 7 CV620-IPs can be connected.**

### 4.3.3 Use of CV620-IPW with Internet Connection

#### 4.3.3.1 Setup before use

- Connecting the screen through HDMI output.
- Press [MENU] on the Remote Control to display the OSD menu.
- Shift down to [Ethernet] to modify and confirm the IP address  
DHCP: Enable/disable the dynamic host configuration protocol  
IP Address: Confirm or modify the IP address of CV620-IPW  
Subnet mask: 255.255.255.0  
Gateway: Preset 192.168.100.254

[Remark] Please modify the above settings based on the LAN setting of the operating environment. To use DHCP, please connect the CV620-IPW to LAN and then confirm IP address.

- After completing settings, press [MENU] to exit the OSD menu.
- After completing setting and confirming IP address, HDMI cable can be disconnected.

#### 4.3.3.2 Start Using

- Connect network cable to CV620-IPW network port to connect CV620-IPW to LAN.
- Press [MENU] on the Remote Control to display the OSD menu.
- Open the browser, and enter the URL of CV620-IPW in the address bar,  
e.g.: <http://192.168.100.150> (default IP address)
- Enter administrator's account and password  
Account: admin (Default)  
Password: 9999 (Default)  
Subnet mask: 255.255.255.0  
Gateway: Preset 192.168.100.254

[Remark 1] For details, please refer to [Chapter 7 Network Function Settings Description](#).

[Remark 2] In addition to browsers, other software such as VLC and QuickTime can be used for operation.

## Chapter 5. Remote Control and Setting Menu

### 5.1 Functions of remote control

Note: The below functions are listed alphabetically.

Item	Description
	Move the lens
Back Light	Turn on/off back light compensation
Camera select	Choose 1 ~ 3 of CV620-IPW
Focus-Manual / Far/Near	Turn on manual focus to adjust the focal length
Focus-Auto	Auto focus
Freeze	Freeze the screen
Home-Enter	Go back to the main page / Execute
Info	Status information
L/R Direction Set	L/R Direction / Normal
Menu	Display OSD menu
Mirror	Rotate the image (OFF / Mirror / Flip / Rotate)
Pan/Tilt Reset	Clear the Pan / Tilt setting
Picture	Switch image effect (OFF / NEG / Black & White)
Power	Power Switch
Preset	Appoint an ID (0 ~ 9) to save the current position data
Reset	Appoint an ID (0 ~ 9) to delete the current position data
Zoom-Fast	Adjust image size
Zoom-Slow	Fine-tune image size

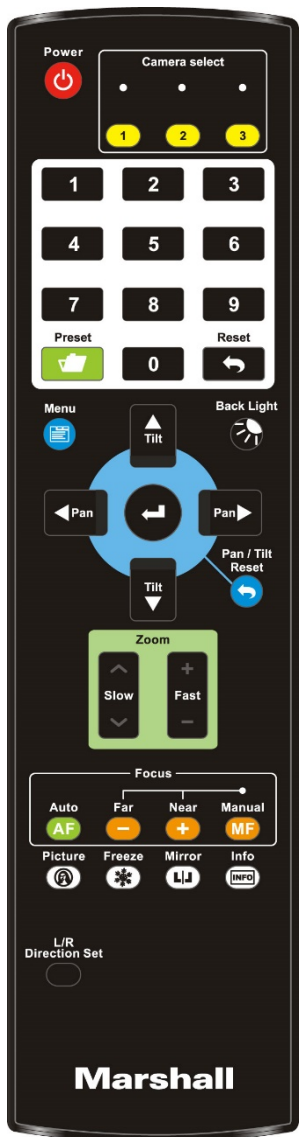

## 5.2 Setting Menu

**Note:** Press **[Menu]** on the **remote control** to enter the setting menu; the **bold underlined** values in the following table are defaults.

1st Level Major Items	2nd Level Minor Items	3rd Level Adjustment Values		Function Descriptions	
Exposure	Mode	1. <b><u>Full Auto</u></b> 2. Shutter Pri 3. Iris Pri 4. Manual 5. White Board 6. Smooth Auto		Exposure mode setting	
	Exposure Comp.	On / <b><u>Off</u></b>		AE Level	
	Exposure Comp. Level	-6~ <b><u>0</u></b> ~5		The value can be adjusted only after <b>Exposure Comp.</b> is activated	
	Shutter Pri		60/30 mode	50/25 mode	Shutter priority setting
			1/10000	1/10000	
			1/5000	1/5000	
			1/3000	1/3000	
			1/2500	1/2500	
			1/2000	1/1750	
			1/1500	1/1250	
			1/1000	1/1000	
			1/725	1/600	
			1/500	1/425	
			1/350	1/300	
			1/250	1/215	
1/180			1/150		
1/120			1/120		
1/100	1/100				
1/90	1/75				
<b><u>1/60</u></b>	<b><u>1/50</u></b>				
1/30	1/25				
1/15	1/12				
1/8	1/6				
1/4	1/3				
1/2	1/2				
1/1	1/1				

	<p><b>Iris Pri</b></p>	<ol style="list-style-type: none"> <li>1. <b>F1.6</b></li> <li>2. F2</li> <li>3. F2.2</li> <li>4. F2.7</li> <li>5. F3.2</li> <li>6. F3.8</li> <li>7. F4.5</li> <li>8. F5.4</li> <li>9. F6.3</li> <li>10. F7.8</li> <li>11. F9</li> <li>12. F11</li> <li>13. F13</li> <li>14. F16</li> <li>15. F18</li> </ol>	<p>Iris setting</p>																																						
	<p><b>Manual Gain</b></p>	<ol style="list-style-type: none"> <li>1. <b>0dB</b></li> <li>2. 2 dB</li> <li>3. 4 dB</li> <li>4. 6 dB</li> <li>5. 8 dB</li> <li>6. 10 dB</li> <li>7. 12 dB</li> <li>8. 14 dB</li> <li>9. 16 dB</li> <li>10. 18 dB</li> <li>11. 20 dB</li> <li>12. 22dB</li> <li>13. 24dB</li> <li>14. 26 dB</li> <li>15. 28 dB</li> <li>16. 30 dB</li> </ol>	<p>Manually set the gain</p>																																						
	<p><b>Manual Speed</b></p>	<table border="1"> <tr> <td>60/30 mode</td> <td>50/25 mode</td> </tr> <tr> <td>1/10000</td> <td>1/10000</td> </tr> <tr> <td>1/5000</td> <td>1/5000</td> </tr> <tr> <td>1/3000</td> <td>1/3000</td> </tr> <tr> <td>1/2500</td> <td>1/2500</td> </tr> <tr> <td>1/2000</td> <td>1/1750</td> </tr> <tr> <td>1/1500</td> <td>1/1250</td> </tr> <tr> <td>1/1000</td> <td>1/1000</td> </tr> <tr> <td>1/725</td> <td>1/600</td> </tr> <tr> <td>1/500</td> <td>1/425</td> </tr> <tr> <td>1/350</td> <td>1/300</td> </tr> <tr> <td>1/250</td> <td>1/215</td> </tr> <tr> <td>1/180</td> <td>1/150</td> </tr> <tr> <td>1/120</td> <td>1/120</td> </tr> <tr> <td>1/100</td> <td>1/100</td> </tr> <tr> <td>1/90</td> <td>1/75</td> </tr> <tr> <td><b>1/60</b></td> <td><b>1/50</b></td> </tr> <tr> <td>1/30</td> <td>1/25</td> </tr> <tr> <td>1/15</td> <td>1/12</td> </tr> </table>	60/30 mode	50/25 mode	1/10000	1/10000	1/5000	1/5000	1/3000	1/3000	1/2500	1/2500	1/2000	1/1750	1/1500	1/1250	1/1000	1/1000	1/725	1/600	1/500	1/425	1/350	1/300	1/250	1/215	1/180	1/150	1/120	1/120	1/100	1/100	1/90	1/75	<b>1/60</b>	<b>1/50</b>	1/30	1/25	1/15	1/12	<p>Manually set the shutter</p>
60/30 mode	50/25 mode																																								
1/10000	1/10000																																								
1/5000	1/5000																																								
1/3000	1/3000																																								
1/2500	1/2500																																								
1/2000	1/1750																																								
1/1500	1/1250																																								
1/1000	1/1000																																								
1/725	1/600																																								
1/500	1/425																																								
1/350	1/300																																								
1/250	1/215																																								
1/180	1/150																																								
1/120	1/120																																								
1/100	1/100																																								
1/90	1/75																																								
<b>1/60</b>	<b>1/50</b>																																								
1/30	1/25																																								
1/15	1/12																																								

		1/8	1/6	
		1/4	1/3	
		1/2	1/2	
		1/1	1/1	
	<b>Manual Iris</b>	<ol style="list-style-type: none"> <li>1. <b>F1.6</b></li> <li>2. F2.2</li> <li>3. F2.2</li> <li>4. F2.7</li> <li>5. F3.2</li> <li>6. F3.8</li> <li>7. F4.5</li> <li>8. F5.4</li> <li>9. F6.3</li> <li>10. F7.8</li> <li>11. F9</li> <li>12. F11</li> <li>13. F13</li> <li>14. F16</li> <li>15. F18</li> </ol>	Manually set the iris	
	<b>Gain Limit</b>	<ol style="list-style-type: none"> <li>1. 8 dB</li> <li>2. 10 dB</li> <li>3. 12 dB</li> <li>4. 14 dB</li> <li>5. 16 dB</li> <li>6. 18 dB</li> <li>7. 20 dB</li> <li>8. 22dB</li> <li>9. 24dB</li> <li>10. 26 dB</li> <li>11. 28 dB</li> <li>12. <b>30dB</b></li> </ol>	Max. limit value of electron gain	
	<b>Iris Limit</b>	<ol style="list-style-type: none"> <li>1. F1.6</li> <li>2. <b>F2.2</b></li> <li>3. F3.2</li> <li>4. F4.5</li> <li>5. F6.3</li> <li>6. F9</li> <li>7. F13</li> <li>8. F18</li> </ol>	Max. limit value of iris	
	<b>WDR</b>	<ol style="list-style-type: none"> <li>1. <b>Disable</b></li> <li>2. 1</li> <li>3. 2</li> <li>4. 3</li> <li>5. 4</li> <li>6. 5</li> </ol>	WDR settings	

White Balance	Mode	<ol style="list-style-type: none"> <li><b>Auto</b></li> <li>Indoor</li> <li>Outdoor</li> <li>One Push WB</li> <li>ATW</li> <li>Manual</li> <li>Sodium Lamp</li> <li>3000K</li> <li>4300K</li> <li>5000K</li> <li>6500K</li> <li>8000K</li> <li>WideAuto</li> </ol>	Select the color temperature mode <ol style="list-style-type: none"> <li>4000k ~ 7000k</li> <li>3200k</li> <li>5800k</li> <li>1700k ~ 10000k</li> <li>1700k ~ 10000k</li> <li>Custom</li> <li>2800k</li> <li>3000K</li> <li>4300K</li> <li>5000K</li> <li>6500K</li> <li>8000K</li> <li>3000k ~ 7000k</li> </ol>
	One Push Trigger	<b>ENTER</b>	One push trigger
	Manual Red	0~ <b>C</b> ~128	Adjustable when the white balance mode is set to <b>Manual</b>
	Manual Blue	0~ <b>C</b> ~128	Adjustable when the white balance mode is set to <b>Manual</b>
Picture	Picture effect	<ol style="list-style-type: none"> <li><b>Disable</b></li> <li>Neg</li> <li>B &amp; W</li> </ol>	Set the picture effect
	Sharpness	0~ <b>C</b> ~15	Adjust the <b>sharpness</b> of the image
	2D NR	<ol style="list-style-type: none"> <li><b>Auto</b></li> <li>Disable</li> <li>1</li> <li>2</li> <li>3</li> <li>4</li> <li>5</li> </ol>	2D noise reduction settings
	3D NR	<ol style="list-style-type: none"> <li>Disable</li> <li>Low</li> <li><b>Typ</b></li> <li>Max</li> <li>Auto</li> </ol>	3D dynamic noise reduction settings
	Image Mode	<ol style="list-style-type: none"> <li>Mode 1</li> <li><b>Mode 2</b></li> <li>Mode 3</li> <li>Mode 4</li> <li>Mode 5</li> <li>Mode 6</li> <li>Custom</li> </ol>	The user may customize his/her desired image mode.
	Image Mode Load	<ol style="list-style-type: none"> <li>Mode 1</li> <li>Mode 2</li> <li>Mode 3</li> <li><b>Mode 4</b></li> <li>Mode 5</li> <li>Mode 6</li> </ol>	Adjustable when the <b>image mode</b> is set to <b>Custom</b> . After selected, the corresponding <b>image mode</b> parameters will be read and applied to <b>Custom</b>
	Brightness	0~ <b>C</b> ~25	Adjustable when the <b>image mode</b> is set to <b>Custom</b>
	Contrast	0~ <b>C</b> ~25	Contrast adjustment; Adjustable when the <b>image mode</b> is set to <b>Custom</b>

	<b>Saturation</b>	0~ <u>C</u> ~25	Adjustable in the <b>Custom Mode</b>
	<b>Black Level</b>	1. <u>Disable</u> 2. Type 1 3. Type 2 4. Type 3 5. Type 4 6. Type 5	Adjustable in the <b>Custom Mode</b>
	<b>Gamma</b>	0~ <u>C</u> ~3	Adjustable in the <b>Custom Mode</b>
	<b>Skin Tone</b>	0~ <u>C</u> ~5	Skin tone setting, adjustable in the <b>Custom Mode</b>
<b>Pan Tilt Zoom</b>	<b>Pan/Tilt Limit</b>	ON/ <u>Off</u>	Turn on/off the angle limit setting
	<b>Pan Right Limit</b>	0~ <u>170</u>	Limit the right angle
	<b>Pan Left Limit</b>	<u>-170</u> ~0	Limit the left angle
	<b>Tilt UP Limit</b>	0~ <u>90</u>	Limit the upward angle
	<b>Tilt Down Limit</b>	<u>-30</u> ~0	Limit the downward angle
	<b>Pan/Tilt Speed</b>	<u>Preset</u> /Low	Adjust Pan/Tilt Speed
	<b>Pan Flip</b>	On/ <u>Off</u>	Activate the reverse Pan command
	<b>Tilt Flip</b>	On/ <u>Off</u>	Activate the reverse Tilt command
	<b>Preset Speed</b>	1. 5 per second 2. 25 per second 3. 50 per second 4. <u>120 per second</u>	Set the rotation speed of the cradle head when Preset is executed
	<b>PTZ Speed Comp</b>	On/ <u>Off</u>	PTZ Speed Compensation
<b>Dig-Effect</b>	<b>Mirror</b>	1. <u>Disable</u> 2. Mirror 3. Flip 4. Mirror + Flip	Set the mode at which the image is turned
<b>Auto Focus</b>	<b>AF Sensitivity</b>	1. Low 2. <u>Middle</u> 3. High	Select the AF triggering speed. The higher the speed is, the faster AF is triggered
	<b>AF speed</b>	Fast / <u>Normal</u>	Focus speed after AF triggering
	<b>AF Frame</b>	<u>Full Area</u> /Center Area	AF frame setting, when central area was set as AF frame, focusing will be on the center of the screen. When Full Frame was set as AF frame, focusing will be calculated based on the full screen
<b>Ethernet</b>	<b>DHCP</b>	<u>On</u> /Off	Enable/Disable DHCP setting using left and right arrow keys and press [ENTER] to apply setting.
	<b>IP Address</b>	<u>192.168.100.150</u>	Press [ENTER] to modify the items; select the item to be modified using left and right arrow keys, and modify the value using numeric keys.
	<b>Subnet mask</b>	<u>255.255.255.0</u>	Press [ENTER] to modify the items; select the item to be modified using left and right arrow keys, and modify the value using numeric keys.

	<b>Gateway</b>	<u>192.168.100.254</u>	Press [ENTER] to modify the items; select the item to be modified using left and right arrow keys, and modify the value using numeric keys.
<b>System</b>	<b>Prompt</b>	On / <u>Off</u>	Turn on/off the prompt information on the display
	<b>IR Receive</b>	<u>On</u> / Off	Turn on/off the infrared reception
	<b>Motionless Preset Tally Mode</b>	On / <u>Off</u>	When the function is enabled, the screen will Freeze when Preset is executed. Freeze will be released after Preset is completed.
	<b>Audio In</b>		
	<b>Audio In</b>	<u>Line In</u> /Mic In	Set Audio In
	<b>Audio Enable</b>	On / <u>Off</u>	Turn on/off sound output
	<b>Audio Volume</b>	0~ <u>10</u>	Volume Setting
	<b>Encode Sample Rate</b>	1. <u>48 KHz(AAC)</u> 2. 44.1 KHz(AAC) 3. 16 KHz(G.711) 4. 8 KHz(G.711)	Set the encode type and sample rate SDI supports the audio output of 48 KHz only.
	<b>Language</b>	<u>English</u> / Chinese	Language
	<b>Output Mode</b>	1. <u>1080p/60</u> 2. 1080p/59.94 3. 1080p/50 4. 1080p/30 5. 1080p/29.97 6. 1080p/25 7. 1080i/60 8. 1080i/59.94 9. 1080i/50 10. 720p/60 11. 720p/59.94 12. 720p/50	Set output resolution
	<b>Protocol</b>	<u>Protocol V</u> / Protocol PD	Protocol V: VISCA Protocol PD: PELCO D
	<b>PD Address</b>	1~ <u>C</u> ~255	The Protocol set to PD allows the camera ID address to be assigned
	<b>Factory Reset</b>	On / <u>Off</u>	Resume the factory default setting
<b>FW Upgrade</b>	On / <u>Off</u>	Upgrade Firmware	
<b>Status</b>			Display the current setting status



## Chapter 6. Descriptions of Major Functions

---

### 6.1 I would like to switch to CV620-IPW

1. Press [**Camera 1 ~ 3**] on the **remote control** to select CV620-IPW.
  - **Camera 1 ~ 3 is selected with IR SELECT.**

### 6.2 I would like to save the current lens position data

1. Hold [**Preset + ID**] on the **remote control** to save the current position data.
  - **ID shall be a digit [0 ~ 9].**
  - **Use VISCA Command to store position data to [0 ~ 127]**

### 6.3 I would like to clear the saved position data

1. Hold [**Reset + ID**] on the **remote control** to clear the given position data.
  - **ID shall be a digit [0 ~ 9].**
  - **Use VISCA command to clear position data stored in [0 ~ 127]**

### 6.4 I would like to turn on the back light compensation function

1. Press [**Back Light**] on the **remote control** to turn on or turn off the back light compensation

### 6.5 I would like to adjust the shooting angle of the lens

1. Press [**Tilt ▲**] or [**Tilt ▼**] on the **remote control** to adjust the angle upward or downward.
2. Press [**Pan ►**] or [**Pan ◀**] on the **remote control** to adjust the angle to right or left.
3. Press [**Pan - Tilt Reset**] on the **remote control** to reset the angle to the center point.

### 6.6 I would like to zoom in/out images

#### 6.6.1 Adjust image size

1. Press [**Fast +**] on the **remote control** to zoom in images.
2. Press [**Fast -**] on the **remote control** to zoom out images.

#### 6.6.2 Fine-tune image size

1. Press [**Slow +**] on the **remote control** to zoom in images.
2. Press [**Slow -**] on the **remote control** to zoom out images.

### 6.7 I would like to adjust the focal length

#### 6.7.1 Auto tune

1. Press [**AF**] on the **remote control** to adjust automatically.

#### 6.7.2 Manual focus

1. Press [**MF**] on the **remote control** to turn on the manual focus function.
2. Press **Focus - [+]** or **Focus - [-]** to adjust.

### 6.8 I would like to adjust the AF speed

#### 6.8.1 Adjust the AF Sensitivity

Triggering speed of focus. The higher the speed is, the faster focus is triggered

To shoot fast-moving objects, **AF Sensitivity** can be set to **[High]** or **[Medium]**, which is applicable to quick focus.

When the environment is too dark to enable auto focus or fixed objects have to be shot in different brightness, **AF Sensitivity** can be set to **[Low]**.

1. Press [MENU] to activate the setting menu.
2. Press [▶] or [◀] to select [Auto Focus].
3. Press [ENTER] to activate.
4. Press [▲] or [▼] to select [AF Sensitivity].
5. Press [ENTER] to activate.
6. Press [▶] or [◀] to select [High / Middle / Low].
7. Press [MENU] to exit.

### 6.8.2 Adjust the AF speed

The focus speed upon triggering **AF Sensitivity**

- **[Normal]** (default): Image flickering may not occur
  - **[Fast]**: Fast focus speed
1. Press [MENU] to activate the setting menu.
  2. Press [▶] or [◀] to select [Auto Focus].
  3. Press [ENTER] to activate.
  4. Press [▲] or [▼] to select [AF speed].
  5. Press [ENTER] to activate.
  6. Press [▶] or [◀] to select [Fast / Normal].
  7. Press [MENU] to exit.

### 6.9 I would like to set the image mode

1. Press [Picture] on the **remote control** to switch [Off / Neg / B&W].

### 6.10 I would like to freeze images

1. Press [Freeze] on the **remote control** to freeze the current image on the display.

### 6.11 I would like to rotate the image

1. Press [Mirror] on the **remote control** to switch [Off / Mirror / Flip / Mirror + Flip].

### 6.12 I would like to change the camera direction

1. Press [L/R Direction Set] on the **remote control** to switch [L/R Direction / Normal].

### 6.13 I would like to display the current status

1. Press [Info] on the **remote control** to display the current status information.

### 6.14 I would like to reset to the default value

Reset to default value using OSD menu

- Press [MENU] → [System] → [Factory Reset] → [On] → [Enter] on the Remote Control and reset to the default value

# Chapter 7. Network Function Settings Description

## 7.1 Web System Requirements

Web Browser: Internet Explorer 8 ~ 11

## 7.2 Online IP Camera

### 7.2.1 Connecting to Internet

Two common connection methods are shown below

1. Connecting via switch or router

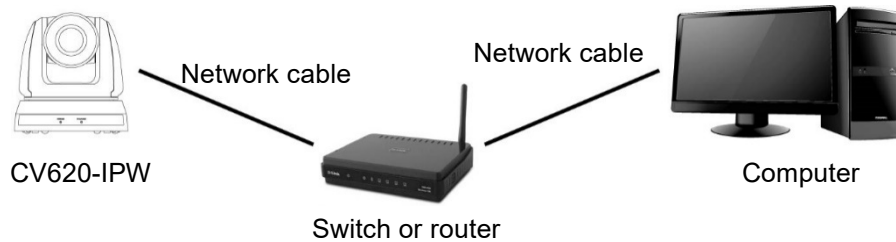

2. To connect directly through network cable, the IP address of the computer should be changed so that it is on the same network segment as the camera; for instance [192.168.100.x](http://192.168.100.x) (preset for camera)

- Connection diagram

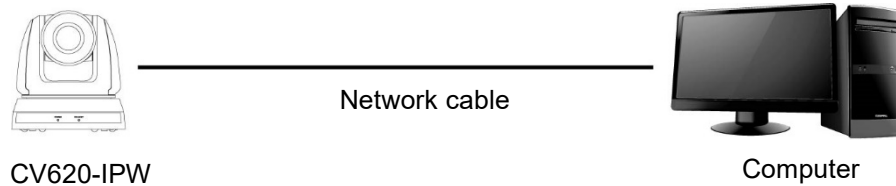

- Change network settings

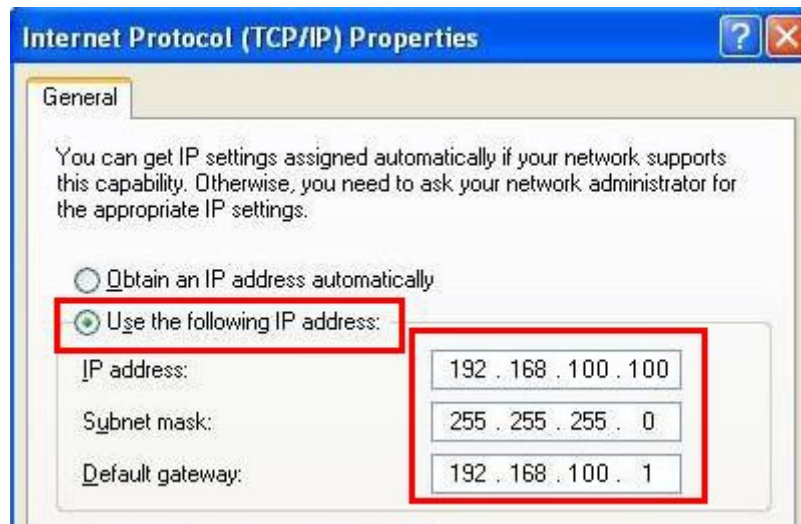

### 7.2.2 Use the web browser

1. Open the IE browser, and enter the URL of CV620-IPW in the address bar, such as: <http://192.168.100.150> (default IP address)
2. Enter administrator's account and password to get started  
 Account: admin (Default)  
 Password: 9999 (Default)

Note: 1. "Web Plugin" must be installed before the first use. Please install the program after downloading according to instructions on the screen (as shown in the following figure)

2. Please login the computer as Administrator to install it
3. After completing installation, please refresh the page.

## Installation Guide

**The "WebPlugin" file will be downloaded automatically in 7 seconds...**

Step:

- 1. Before you begin, close your web browser (i.e. Internet Explorer, Firefox, Chrome, etc.) first.

IE	Firefox	Chrome

- 2. Double-click "WebPlugin.exe" to start the actual installation process.

WebPlugin.exe

- 3. After installation is completed, open the web browser and type in the IP address of the IP Camera

http://(IP Address) 🔍 →

### 7.2.3 Use RTSP player

In addition to browser, other RTSP methods can be used for connection, such as VLC and Quick Time RTSP connection address:

- RTSP main stream (h264)=><rtsp://VC IP Address:8557/h264>
- RTSP second stream (h264) =><rtsp://VC IP Address:8556/h264>
- RTSP second stream (MJPEG) or single stream in MJPEG=><rtsp://VC IP Address:8555/mjpeg>

1. Open the software to enter URL: <rtsp://192.168.100.150:8557/h264>

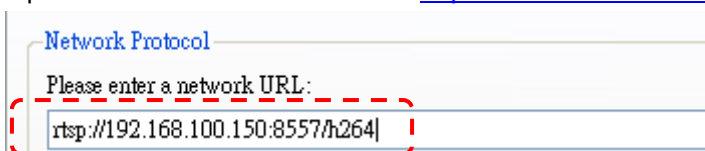

### 7.2.4 Use RTMP connection

Support RTMP connection. If RTMP server is set up, RTMP connection function can also be opened Please log into CV620-IPW webpage to change RTMP of network setting as described in [7.2.2 Use the Web Browser](#)



Note: To upload to YouTube for online viewing, please refer to [7.3.9 Settings – Audio Setting](#) and turn on sound

### 7.3 Web Page Function Description

#### 7.3.1 Login Screen

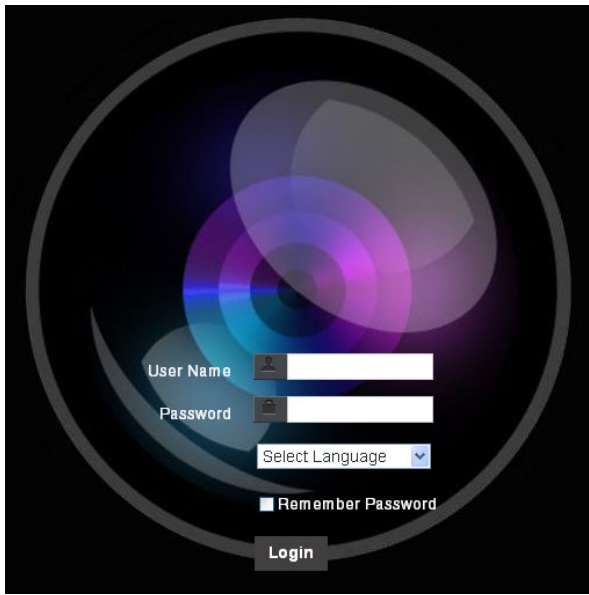
	Username: Enter user account
	Password: Enter user password
	Select Language: Select language from English, Traditional Chinese and Simplified Chinese
	Remember password: Remember the password so that you do not need to type it next time
	Login: Log into the administrator screen on the website

#### 7.3.2 Preview Screen

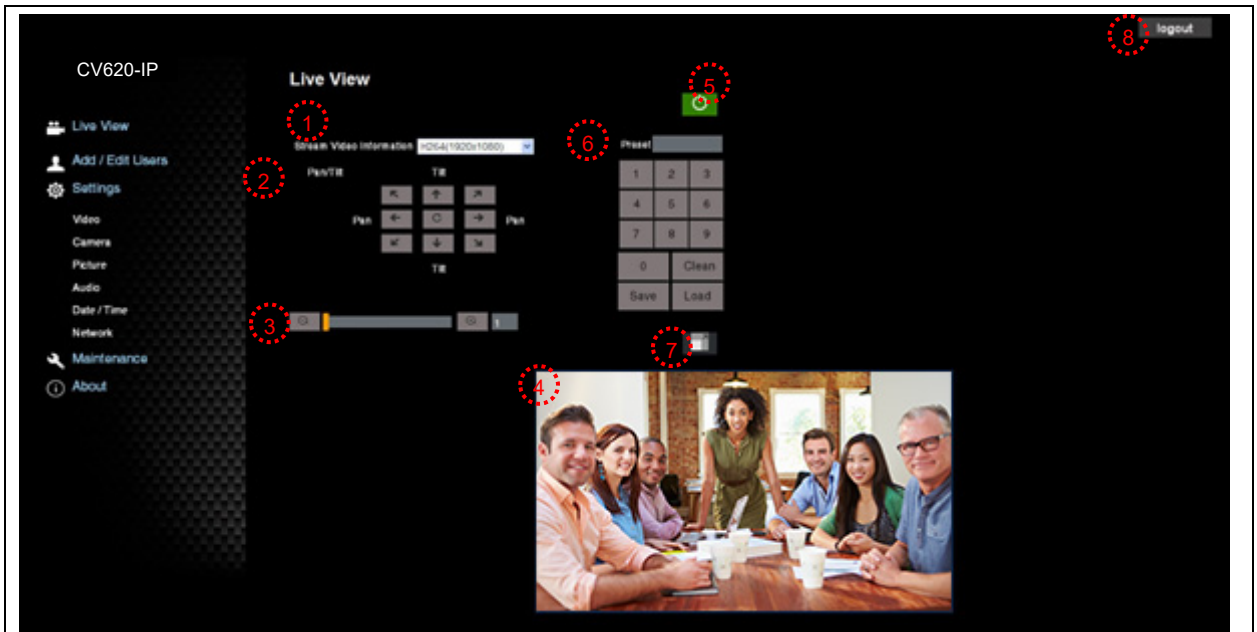

1. Information about image encoding form and resolution
2. Rotate camera angle
3. Zoom in/out
4. Preview window
5. Power off CV620-IPW
6. Apply/Set preset
7. Switch to Full Screen
8. Logout

7.3.3 Account management screen

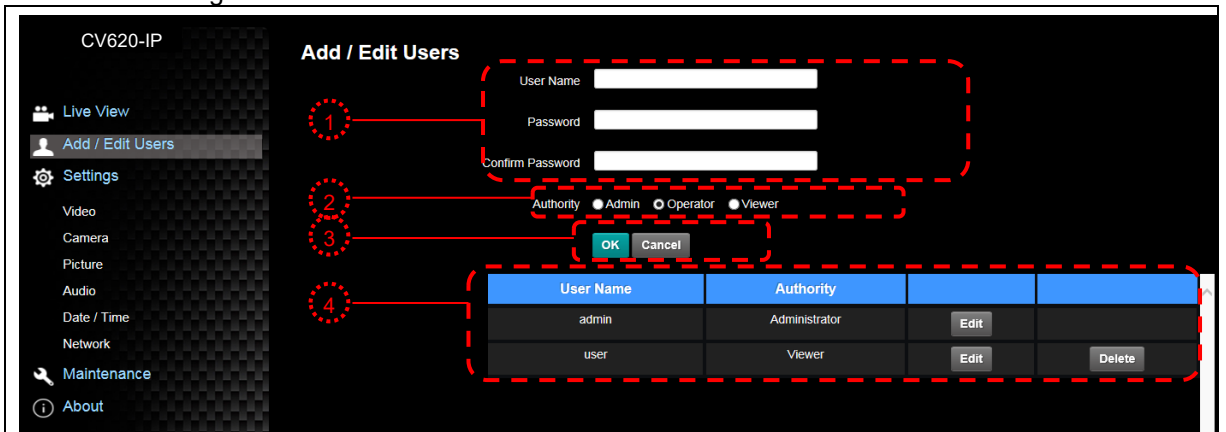

1. Enter new username and password
2. Set the permissions: Description for permissions is listed in the following table
3. Apply
4. List of accounts:  
 Edit: Change password and permission of new account  
 Delete: Delete new account

Note: Reference for User Permissions

User Type	Admin	Operator	Viewer
View images	Y	Y	Y
Settings	Y	Y	N
User accounts management	Y	N	N

7.3.4 Settings – Video Setting

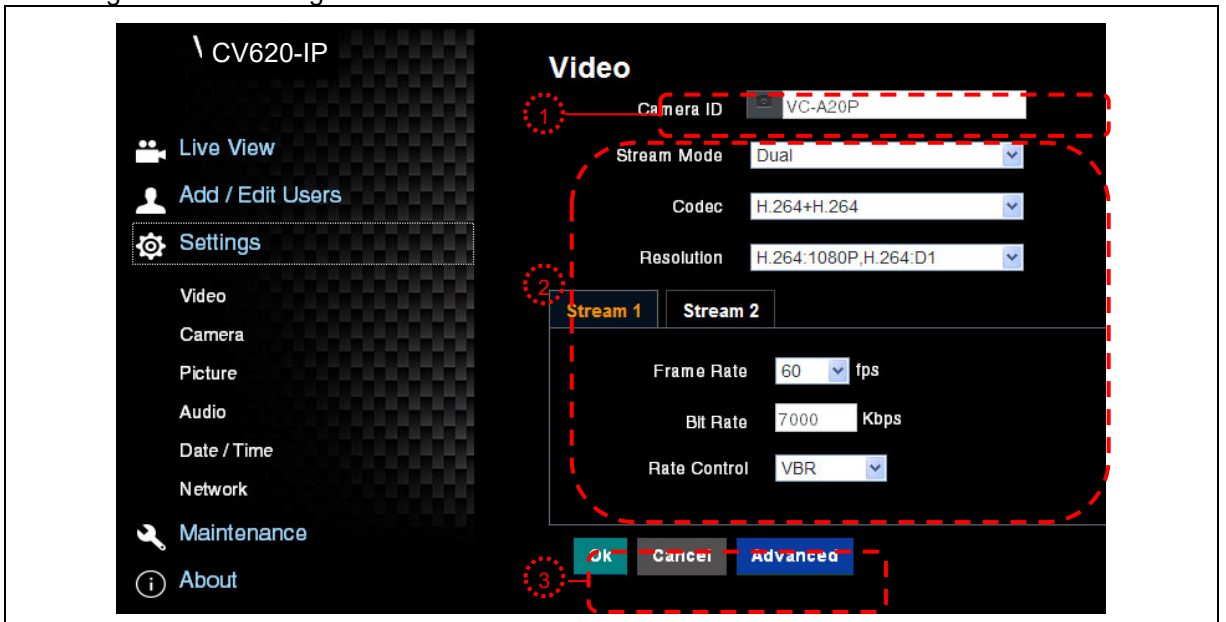

1. Camera name: Change camera name on this page
2. Select rate and encoding
3. Storage setting; for advanced settings, see [7.3.5 Settings –Advanced Video Setting](#)

7.3.5 Settings –Advanced Video Setting

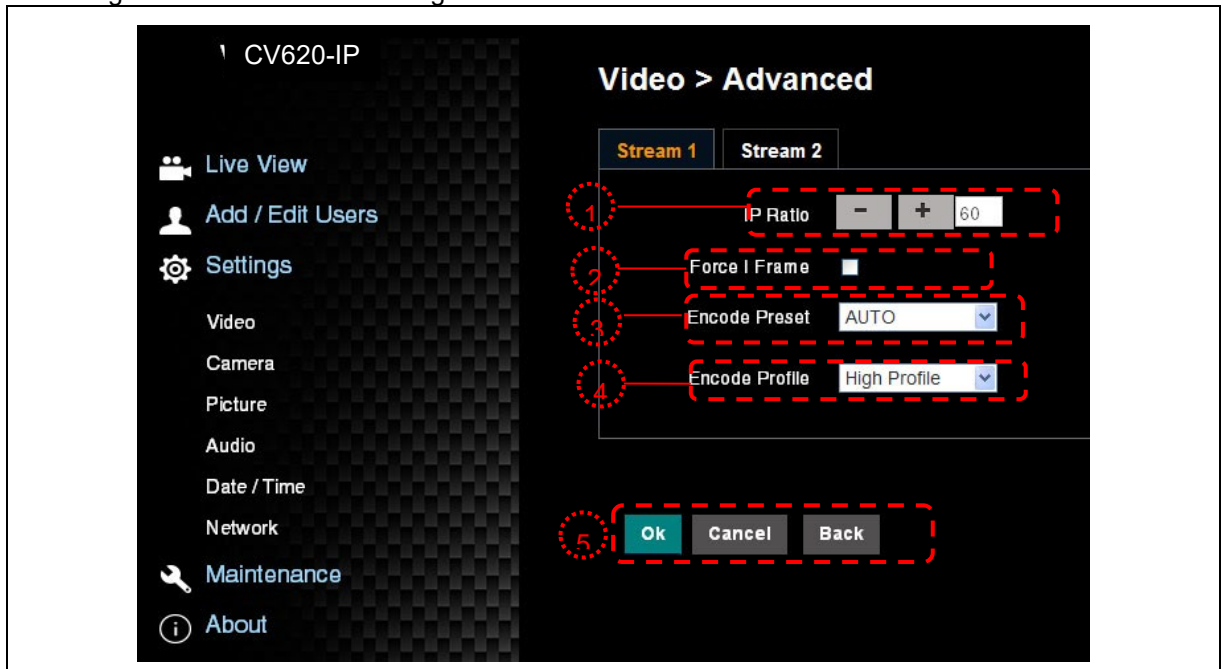

1. IP Ratio: Set IP Ratio, from 1 to 60
2. Force I Frame : Check this item to insert IDR frame into specified series flow and apply its setting. User's setting will be reserved and displayed in GUI interface
3. Encode Preset : <b>Auto:</b> Select between speed and quality depending on the encoding method used (e.g. HIGH_SPEED mode for refresh rate of 60 frames per second and HIGH_QUALITY mode for high image quality) <b>HIGH_SPEED:</b> Refresh rate of 60 frames per second is available <b>HIGH_QUALITY:</b> Higher image quality can be obtained. <b>SVC:</b> SVC opened encoding mode is applicable to RTSP series flow of 8601, 8602, 8603 and 8604 ports, different refresh rate for different ports. See remark
4. Encode Profile: Encoded Information
5. Preset Save

Note: SVC connection address: rtsp://VC IP Address:Port/h264

1. **60Frame** : rtsp://VC IP Address:8557/h264, E.g.: <rtsp://192.168.100.150:8557/h264>
2. **30Frame** : rtsp://VC IP Address:8601/h264, E.g.: <rtsp://192.168.100.150:8601/h264>
3. **15Frame** : rtsp://VC IP Address:8602/h264, E.g.: <rtsp://192.168.100.150:8602/h264>
4. **7Frame** : rtsp://VC IP Address:8603/h264, E.g.: <rtsp://192.168.100.150:8603/h264>
5. **3Frame** : rtsp://VC IP Address:8604/h264, E.g.: <rtsp://192.168.100.150:8604/h264>

7.3.6 Setting - camera

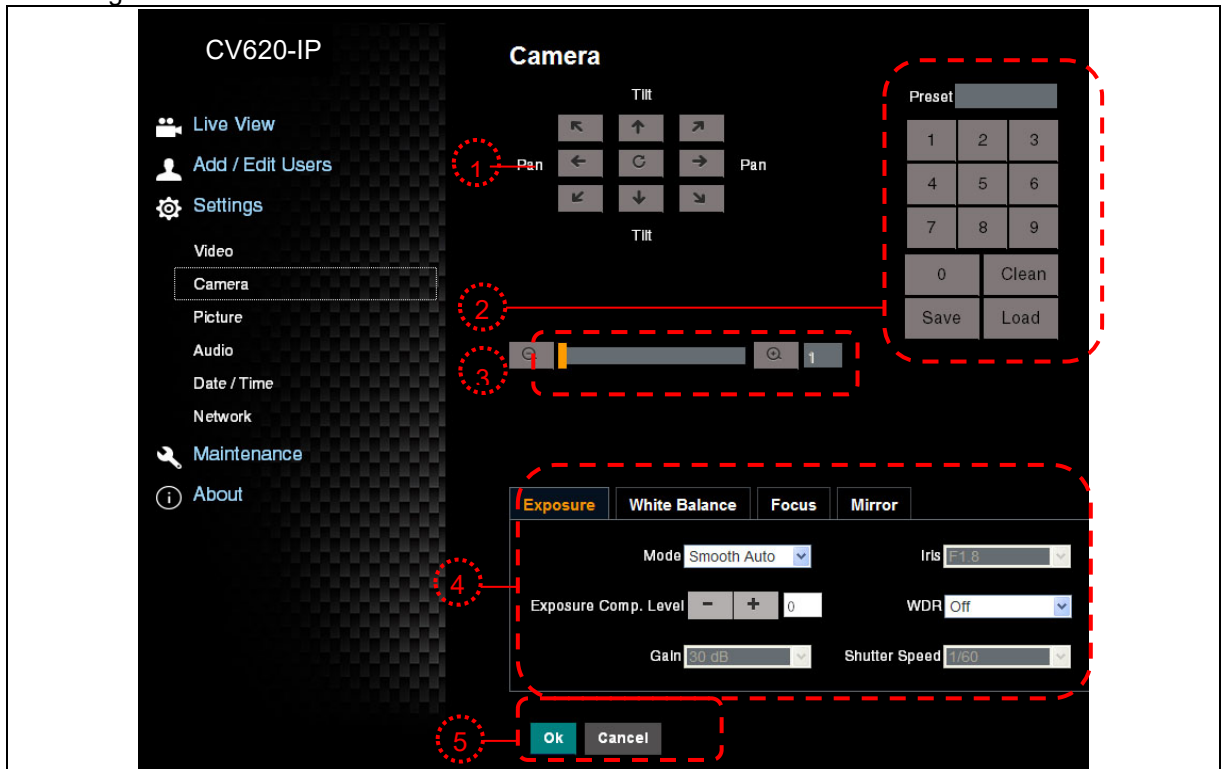

1. Rotate camera lens angle
2. Save/Read preset
3. Adjust image size
4. Adjust camera settings. Please refer to [7.3.7 Settings - Advanced Camera Setting](#)
5. Preset Save

7.3.7 Settings –Advanced Camera Setting

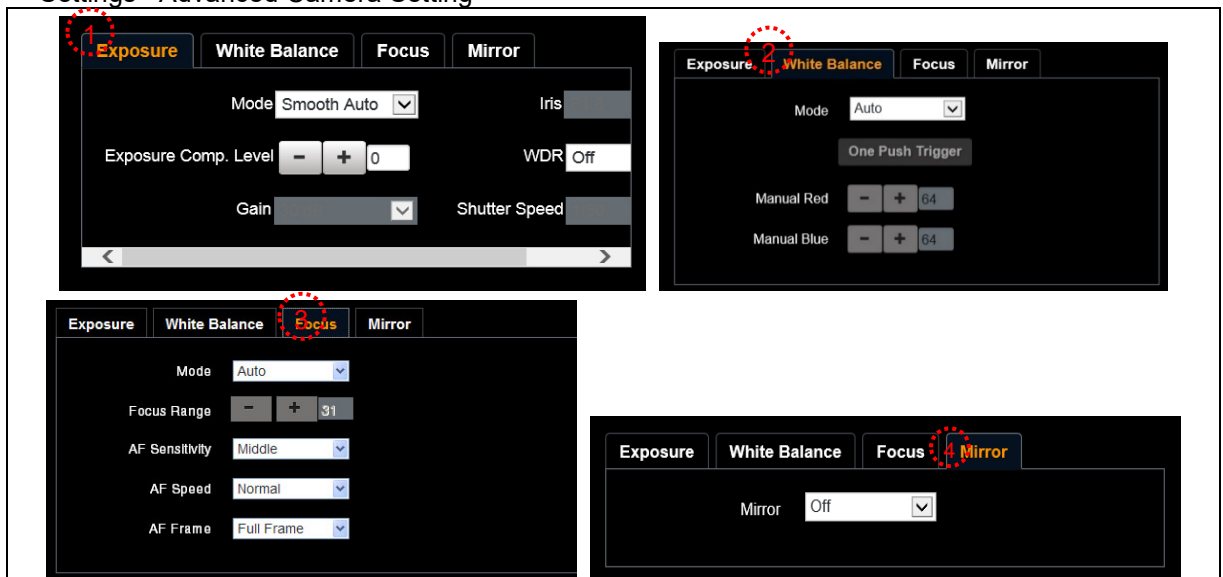

- 1.. **Exposure:**
- **Mode:** Select exposure mode
  - **Exposure Comp. Level:** Select exposure compensation level
  - **Gain:** Adjust gain restriction
  - **Iris:** Iris setting



	<ul style="list-style-type: none"> <li>● <b>WDR:</b> WDR settings</li> <li>● <b>Shutter Speed:</b> Shutter settings</li> </ul>
2. White Balance:	<ul style="list-style-type: none"> <li>● <b>Mode:</b> Select the color temperature mode</li> <li>● <b>Open Push Trigger:</b> Single color temperature execution adjustment</li> <li>● <b>Manual Red/Blue:</b> Manually adjust blue/red color temperature</li> </ul>
3. Focus:	<ul style="list-style-type: none"> <li>● <b>Mode:</b> Select manual/automatic focus</li> <li>● <b>Focus Range:</b> Set focus range</li> <li>● <b>AF Sensitivity:</b> Set automatic focus sensitivity</li> <li>● <b>AF Speed:</b> Set automatic focus speed</li> <li>● <b>AF Frame:</b> Set automatic focus range</li> </ul>
4. Mirror:	<ul style="list-style-type: none"> <li>● <b>Mirror:</b> Set automatic flip mode</li> </ul>

7.3.8 Settings – Picture Setting

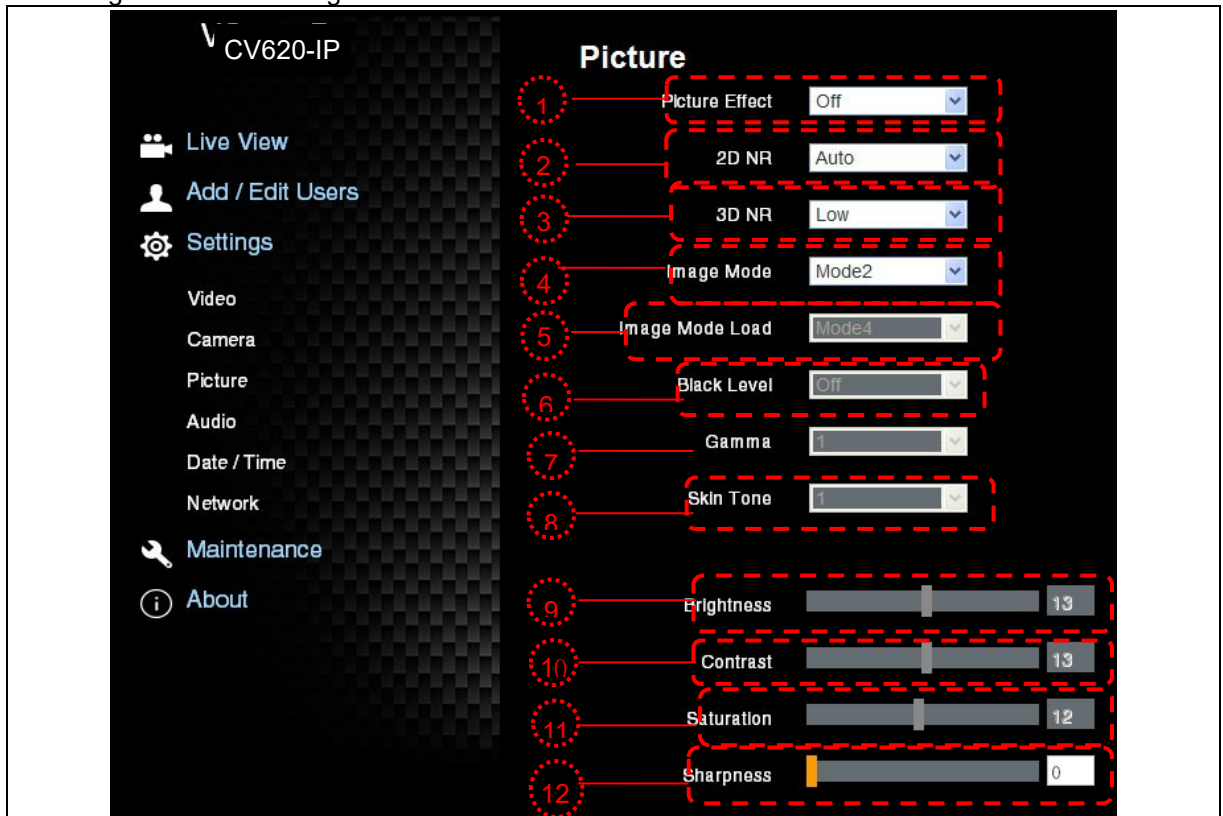

1. <b>Picture Effect:</b> Set the picture effect
2. <b>2D NR:</b> 2D noise reduction settings
3. <b>3D NR:</b> 3D dynamic noise reduction settings
4. <b>Image Mode:</b> The user may customize his/her desired image mode
5. <b>Image Mode Load:</b> Adjustable when <i>Image Mode</i> is set to <i>Custom</i> , similar to OSD
6. <b>Black Level:</b> Adjustable when <i>Image Mode</i> is set to <i>Custom</i> , similar to OSD
7. <b>Gamma:</b> Adjustable when <i>Image Mode</i> is set to <i>Custom</i> , similar to OSD
8. <b>Skin Tone:</b> Skin tone settings; adjustable when <i>Image Mode</i> is set to <i>Custom</i> , similar to OSD
9. <b>Brightness:</b> Adjustable when <i>Image Mode</i> is set to <i>Custom</i> , similar to OSD

10. <b>Contrast:</b> Adjustable when <i>Image Mode</i> is set to <b>Custom</b> , similar to OSD
11. <b>Saturation:</b> Adjustable when <i>Image Mode</i> is set to <b>Custom</b> , similar to OSD
12. <b>Sharpness:</b> Adjust the <b>sharpness</b> of the image

7.3.9 Settings – Audio Setting

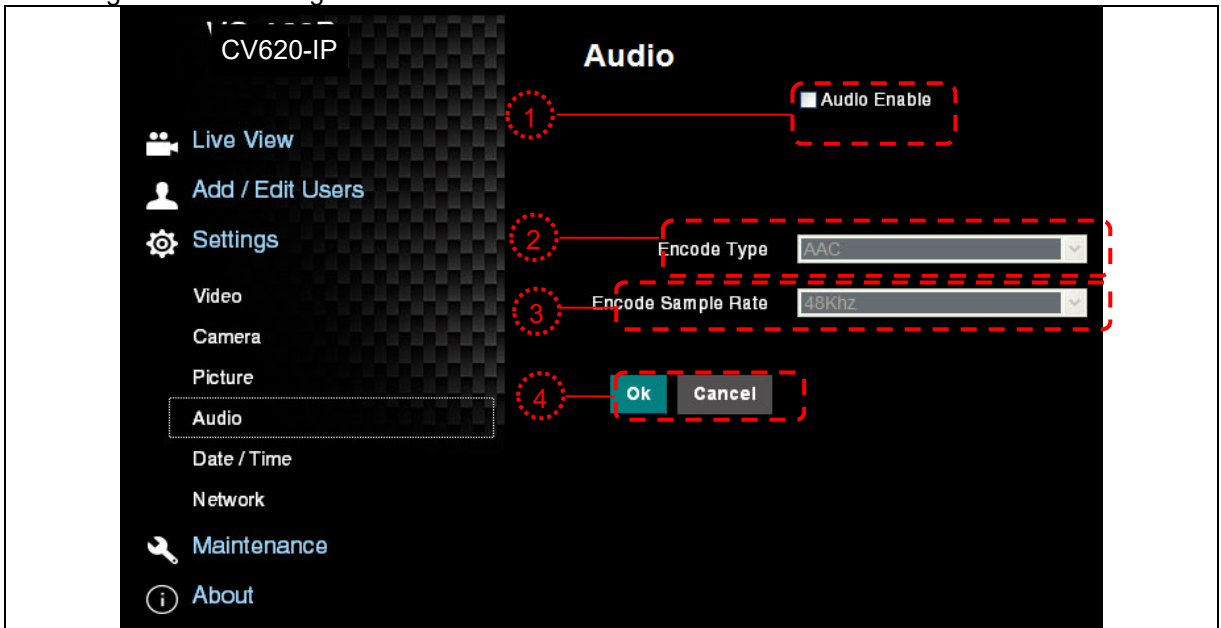

1. Turn on/off sound
2. Set MIC In/Line In
3. Set <b>Encode Type (ACC / G.711)</b>
4. Set <b>Encode Sample rate</b>
5. Preset Save

7.3.10 Settings- Date/ Time Setting

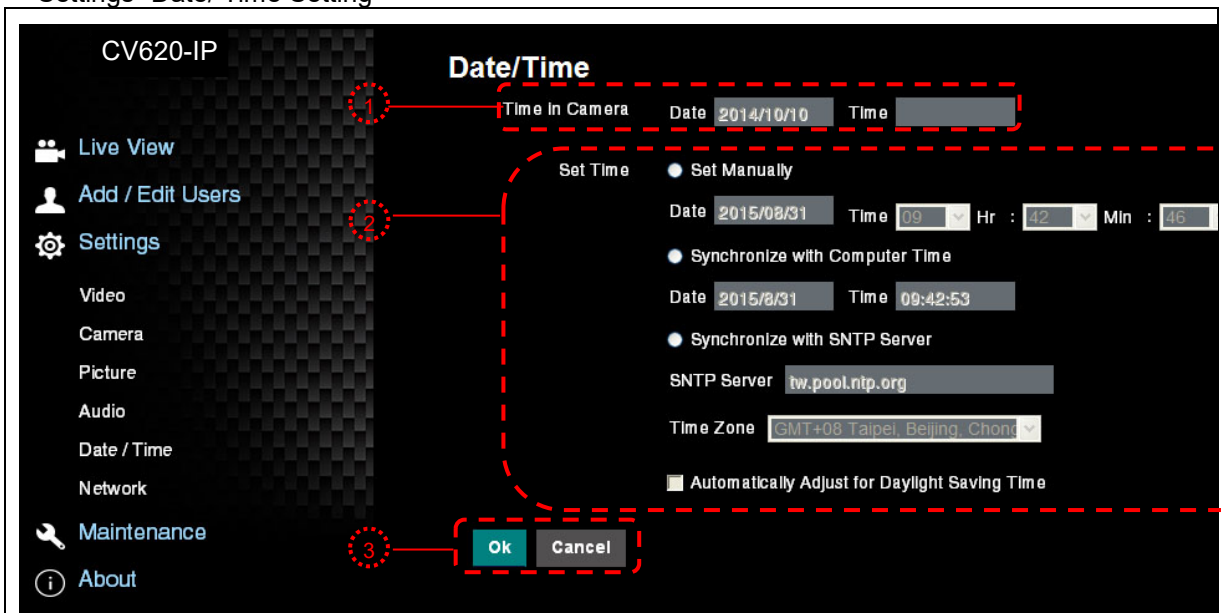

1. Current camera date and time
2. Set the Time: Manual setting/synchronous computer time/synchronous SNTP server time/time of automatic adjustment of daylight saving

3. Preset Save

Note: SNTP server address: Please change in network setting

7.3.11 Setting -- Network and Port Setting

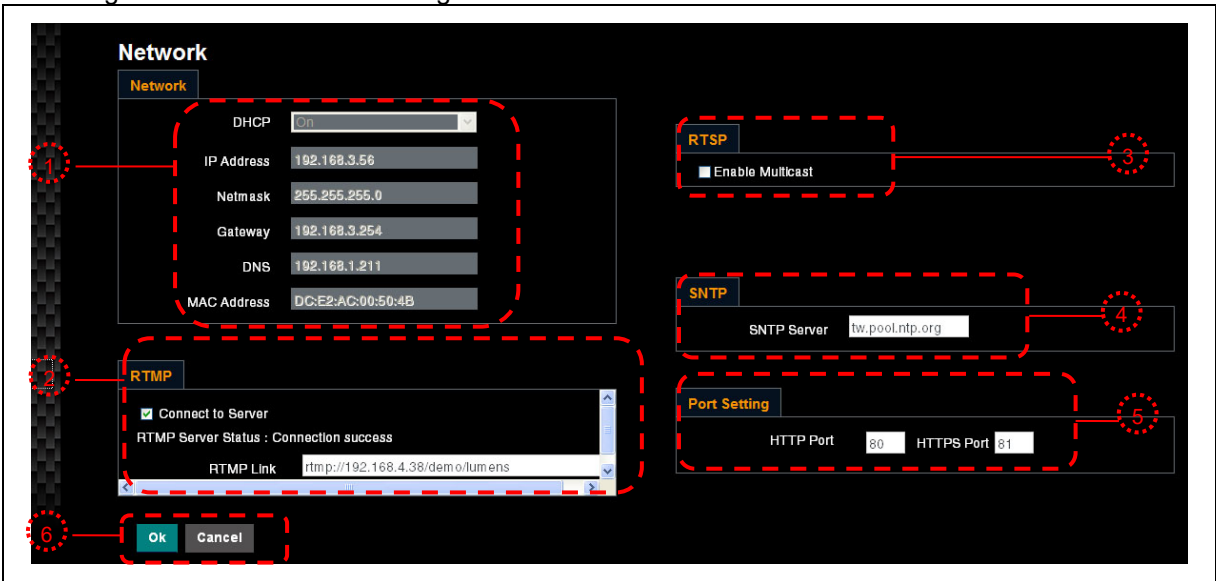

- 1. Network address of camera: Change of setting is available only when DHCP function of camera is turned off; please turn off DHCP function using CV620-IPW screen menu, and for setting of each item of screen menu, see [5.2 Setting Menu](#)
- 2. Set RTMP: Set connection address of RTMP depending on RTMP Server setting
- 3. Set RTSP: Enable/Disable Multicast  
Note: It is suggested to enable Multicast when the number of users online watching the live image simultaneously is more than 4.
- 4. Set SNTP: Set SNTP Server IP
- 5. Set HTTP port. The default Port value is 80  
Note: Change of setting is available only when DHCP function of camera is closed
- 6. Preset Save

## Chapter 8. DIP switch setting

Note: Please turn off the machine before changing DIP switch setting.

### 8.1 DIP SWITCH

#### 8.1.1 OUTPUT Switch

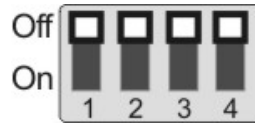

Output Mode	Setting	Output Mode	Setting
1920x1080/60p		1920x1080/50p	
1920x1080/30p		1920x1080/25p	
1920x1080/60i		1920x1080/50i	
1280x720/60p		1280x720/50p	
1080/59.94p		1080/59.94i	
1080/29.97p		720/59.94p	

#### 8.1.2 IR SELECT



ID	Setting
1	
2	
3	

#### 8.1.3 Camera Address Selector



Setting	Function Descriptions
0~7	ID 0~7
8~9	Reserved

### 8.1.4 System Switch



Setting	Function Descriptions
DIP 1	RS-232C/RS-422 selector OFF : RS-232C / ON : RS-422
DIP 2	Infrared signal output switch OFF : Off / ON : On
DIP 3	Communication baud rate selector OFF : 9600 / ON : 38400
DIP 4	Reserved

## 8.2 RS-422 Connection

### 8.2.1 RS-422 Pin Description

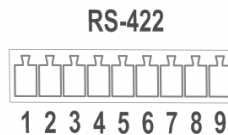

Pin NO.	Function
1	RXD OUT -
2	RXD OUT +
3	TXD OUT -
4	TXD OUT +
5	GND
6	RXD IN -
7	RXD IN +
8	TXD IN -
9	TXD IN +

**Note:**

Please connect IN+ to OUT+ when connecting to SONY products  
For non-SONY products, it may be necessary to connect IN+ to OUT-

### 8.2.2 Use RS-422 Connection

1. Hold the two sides of RS-422 connector and pull out in the direction shown by the arrow in the figure below

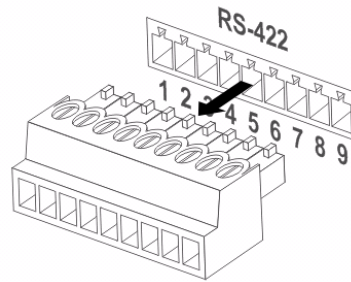

2. Peel off a section of copper wire (AWG Nos.28 to 18) and insert it into the connector hole; then use flat screw driver to fix it

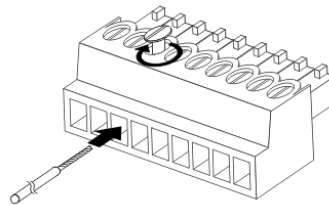

3. Insert the wired RS-422 connector back to the camera. Now the connection is completed

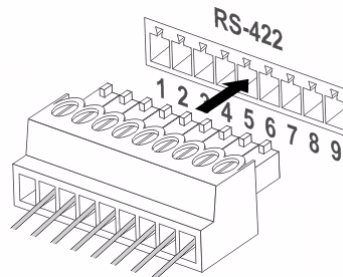

**Note:** When RS-422 connection is being used, do not use RS-232C connection.

## Chapter 9. Troubleshooting

This chapter describes problems you may encounter while using CV620-IPW. If you have questions, please refer to related chapters and follow all the suggested solutions. If the problem still occurred, please contact your distributor or the service center.

No.	Problems	Solutions
1.	<b>Boot without power signal</b>	<ol style="list-style-type: none"> <li>1. Make sure you have plugged in the power cord.</li> <li>2. Make sure the Service DIP switch is Off.</li> </ol>
2.	<b>There is no image output from CV620-IPW</b>	<ol style="list-style-type: none"> <li>1. Check the power.</li> <li>2. Check if DIP switch is properly set. Please refer to <a href="#">Chapter 8 DIP Switch Setting for related settings</a>.</li> <li>3. Make sure the display supports the output resolution; in general, the resolution is 1080p60/1080i60/720p60.</li> <li>4. Replace the cables and make sure they are not faulty.</li> </ol>
3.	<b>CV620-IPW image is severely delayed</b>	Please use 1080p or 720p 60/50 Hz signals rather than 25/30 Hz signals.
4.	<b>Not working after changes to DIP Switch setting</b>	After completing DIP Switch setting, unplug and reconnect the power cord and turn on the machine to change the setting.
5.	<b>CV620-IPW cannot be operated by remote control</b>	<ol style="list-style-type: none"> <li>1. Please confirm if the Camera Select on the remote control can be used together with the IR Select on CV620-IPW.</li> <li>2. Please prevent CV620-IPW from direct sunshine.</li> <li>3. Make sure the energy-saving bulb and the IR touch screen are as far as possible to avoid interference.</li> <li>4. When several CV620-IPW are connected in the same area, the operation of two remote controls at the same time may result in signal interference. It is recommended to use one remote control only.</li> </ol>
6.	<b>The device cannot be controlled with Codec</b>	<ol style="list-style-type: none"> <li>1. Please consult the distributor to make sure the firmware version is the latest one. The steps to check version is as follows: <ol style="list-style-type: none"> <li>1.1 Press [MENU] on the remote control</li> <li>1.2 Choose [Status]</li> <li>1.3 Go to Page 5 of [System]</li> <li>1.4 Make sure the firmware version is correct.</li> </ol> </li> <li>2. Make sure the connection is correct (RS-232/422 Input).</li> <li>3. Make sure System Switch DIP 1 and DIP 3 are correct.</li> </ol>
7.	<b>The device cannot be controlled with RS-232/RS422</b>	<ol style="list-style-type: none"> <li>1. Make sure the connection is correct (RS-232/422 Input).</li> <li>2. Make sure System Switch DIP 1 and DIP 3 are correct.</li> </ol>
8.	<b>Whether the Internet can be used for operation</b>	Please refer to <a href="#">Chapter 7 Network Function Description</a> for the Internet usage

**Marshall Electronics, Inc.**

**20608 Madrona Avenue  
Torrance, CA 90503**

Phone: (310) 333-0606 / (800) 800-6608  
Fax: (310) 333-0688

[www.marshall-usa.com](http://www.marshall-usa.com)