

Marshall Electronics

VS-102- HDSDI / HDI

HD Video Server
H.264 Encoder / Decoder



User Manual

Copyright © May 2012, Marshall Electronics, Inc.
All Rights Reserved. This document may not be copied.

Trademarks

Other trademarks used in this document are registered trademarks or manufacturer or vendor trademarks associated with the products.

Disclaimer

Product options and specifications can be changed without notice. The information in this manual is furnished for informational use only and should not be construed as a commitment by Marshall Electronics, Inc. Marshall Electronics, Inc. assumes no responsibility or liability for any errors or inaccuracies that may appear in this publication.

Safety Precaution

**We appreciate your video server purchase.
Before installing the product, please read the following with care.**

- ✧ Make sure to turn off the power before installing video server.
- ✧ Do not install under direct sunlight or in dusty areas.
- ✧ Make sure to use the product within the temperature and humidity specified.
- ✧ Do not operate the product in presence of vibrations or strong magnetic fields.
- ✧ Do not put electrically conducting materials in the ventilation hole.
- ✧ Do not open the top cover of the products. It may cause a failure or electric shock on the components.
- ✧ To prevent from overheating, keep the distance at least 10 cm from the ventilation hole.
- ✧ Check for correct voltage before connecting the power.

1- Introduction

1 - Introduction.....	4
1.1 About this Manual.....	4
1.2 Features.....	4
1.3 Product and Accessories.....	5
1.4 System Connections.....	8
2 - Installation.....	11
2.1 Connecting Video.....	11
2.2 Connecting Audio.....	11
2.3 Connecting Serial Ports.....	11
2.4 Connecting Sensor & Alarm.....	11
2.5 Connecting Power.....	11
2.6 Check If It Works.....	12
3 - System Operation.....	13
3.1 Remote Video Monitoring.....	13
3.2 Initialization of IP Address.....	14
4 - Remote Configuration.....	19
4.1 System Configuration.....	19
4.2 Video Configuration.....	22
4.3 Audio Configuration.....	27
4.4 Network Configuration.....	29
4.5 Serial Configuration.....	36
4.6 Event Configuration.....	39
4.7 Preset Configuration.....	44
4.8 Record Configuration.....	45
4.9 User Configuration.....	52
5 - Decoder Configuration.....	54
5.1 System Configuration.....	54
5.2 Video Configuration.....	55
5.3 Network Configuration.....	56
5.4 Event Configuration.....	58
5.5 Display Configuration.....	60
6 - VS Manager.....	61
7 - Appendix.....	62

1- Introduction

1.1 About this Manual

This User Manual provides information on installation setup, operation of the video server, as well as troubleshooting tips.

1.2 Features

Video Server is a video and audio transmission system that provides broadcast quality audio and video, based on IP network through LAN, ADSL/VDSL, and wireless LAN. A Video Server can operate in an Encoder Mode or a Decoder Mode. An Encoder System compresses and transmits media data, while a Decoder System receives and decompresses media data.

Video

- Highly Efficient Compression Algorithm; H.264 & MJPEG support
- Wide range of Transmission Rates: 32kbps ~ 10mbps
- Various Transmission Modes: CBR or VBR
- Motion Detection

Audio

- Multi-Transmission Mode: Uni-Directional Mode (IP-Server to Client PC or Decoder/ Client PC or Decoder to IP-Server), Bi-Directional Mode

Network

- Fixed IP & Dynamic IP (DHCP) support
- 1:1, 1:N support
- Multicasting
- Automatic Transmit Rate Control according to network conditions
- OnVIF, PSIA compliant

Serial Data

- RS-485 support
- Data Pass-Through Mode: Serial Data Communication between IP Camera and Decoder
- Data Pass-Through Mode: Serial Data Communication between Encoder-Decoder

Sensor and Alarm

- Supports direct connections of External Sensor and Alarm Devices
- Event Alarm

1- Introduction

USB

- Connection to internal or external USB storage for remote access, recording and playback

User Interface

- Diagnose and upgrade through dedicated program called VS Manager
- System Configuration using Internet Explorer

High Reliability

- Reliable Embedded System
- System Recovery by Dual Watch-Dog Functions

1.3 Products and Accessories



Video Server



User Manual

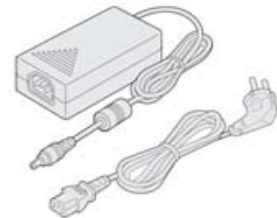

Power Adapter & Cable

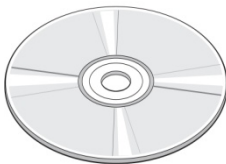

Software CD

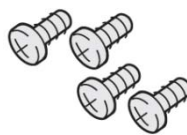

Screws

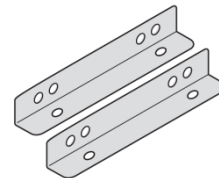

Brackets

1- Introduction

Part Names and Functions

Front View

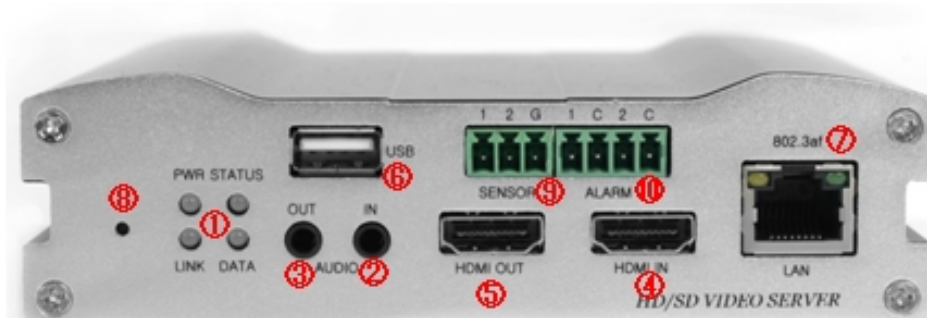

No.	Parts	Function
1	LED	Display System Status
2	Audio Input	Audio Input
3	Audio Output	Audio Output
4	HDMI Input	HDMI Video Input
5	HDMI Output	HDMI Video Output
6	USB Port	USB 2.0
7	LAN	100/10-Base-T Ethernet
8	Reset Button	Initialization of Network Setting
9	Sensor	Sensor Input
10	Alarm	Alarm or Relay Output

1- Introduction

Rear View



No.	Part	Function
1	Power	DC +12V Power Input
2	RS-422/485	Serial Port for PTZ Control
3	RS-232	Serial Port for PTZ Control
4	Composite In/Output	Composite Video Input / Output
5	HD/SD-SDI In/Output*	HD/SD-SDI Video Input / Output

**HD/SD-SDI Output is optional*

1-Introduction

1.4 System Connections

Video Server operates as one of two modes; **Encoder** or **Decoder**. Video Server Systems can be connected in either **1-to-1** where one encoder is connected to one decoder or **1-to-multiple** where one encoder connected to many decoders.

The following chart shows status of video, audio and serial data on each mode:

System Mode	Video	Audio	Serial Data
Encoder	Transmit	Transmit/Receive	Transmit/Receive
Decoder	Receive	Transmit/Receive	Transmit/Receive

Therefore, the system modes are defined by the video communication and all system modes are capable of bi-directional transmission of audio or serial data.

Topology

Generally, the Encoder and Decoder are connected in 1-to-1 mode. To support specific situation, 1-to-multiple connection is also supported.

- **1:1 Connection (Unidirectional Transmission)**



The most commonly used configuration is 1-to-1 connection. An Encoder is installed at a site where video images can be transmitted and a Decoder is installed at a center location to receive and view the video images on monitors. Audio and Serial data are transferred in either direction. An Encoder and Decoder can be connected by setting the Encoder's Address for the Decoder's Remote IP.

1- Introduction

- **1:N Connection (Uni-Directional Transmission)**

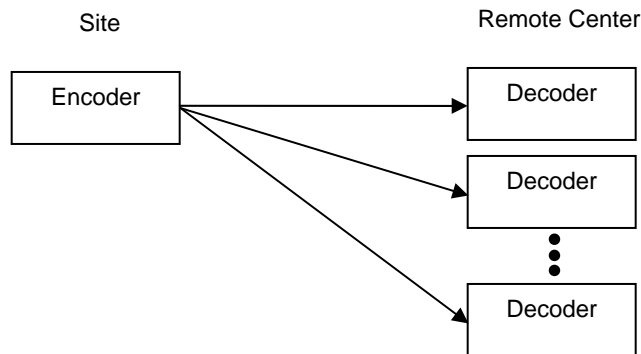

In this configuration, a site can be monitored from many remote center locations. Maximum connections would be limited by the network bandwidth.

Functionally, the VMS (Video Management System) software can replace the decoder.

Multicast Mode

In the Network Supporting Multicast Mode, if Multicast is setup as a system protocol, you can use bandwidth efficiently regardless of the number of decoders. In the 1:N connection, a large number of decoders can receive audio and video data from an encoder by using a single streaming transmission.

- **Relaying**

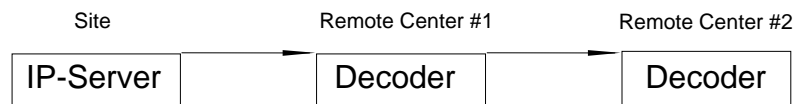

In this arrangement, video and audio can be re-transmitted from a center to another center. The arrangement is useful when the network bandwidth at the site is limited while there is more than one center wanting to monitor the site.

1- Introduction

- **VMS (Video Management System)**

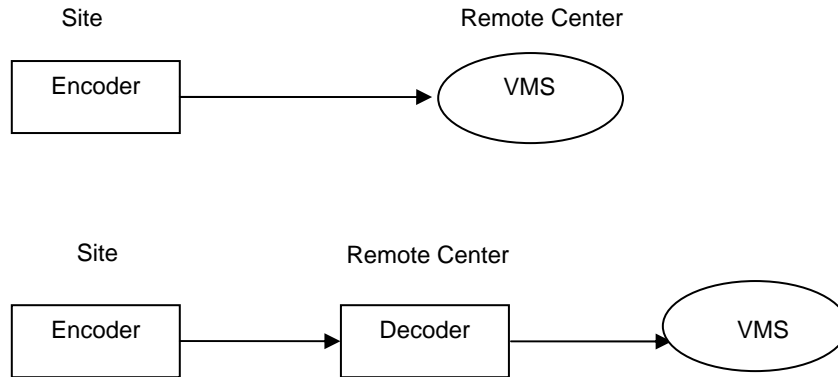

VMS (Video Management System) is a Windows based remote monitoring program to access multiple encoders for real-time monitoring or control of the encoders and connected cameras. Please refer to VMS User Manual for more information on VMS.

2- Installation

2.1 Connecting Video

- **Encoder System**
Connect camera video output line to the encoder (video server) video input port.
- **Connecting with Megapixel Camera**
Connect a camera which supports HDMI or HD-SDI output to the HDMI or HD-SDI Input port of video server accordingly.
- **Connecting with D1 Resolution Camera**
Connect a camera to the Video Input port of video server accordingly.
- **Decoder System**
Connect a monitor to HDMI or COMPOSITE (HD-SDI) Output port of video server accordingly.

2.2 Connecting Audio

Audio is **Full-Duplex**. It is possible to set the mode as **Tx-only**, **Rx-only** or **Tx-Rx**.

- Connect audio input and output ports to audio devices accordingly.
- The Audio signal required is line level, so audio equipment with an amp, mixer or other amplifier should be used.

2.3 Connecting Serial Ports

For camera control, PTZ Controller (keyboard) and Receiver can be connected to Serial Ports. Two corresponding Serial Ports in the Encoder and Decoder which are connected 1-to-1, works in Pass-Through Mode. This means that commands at a local system's COM1 Port will be transparently passed to the remote system's COM1 Port. Commands at a local system COM2 Port will pass to the remote system's COM2 Port.

2.4 Connecting Sensor and Alarm

Connect Sensor and Alarm Devices to corresponding terminals accordingly.

2.5 Connecting Power

After confirming the Power Source, connect Power Adaptor and connect the 12VDC Connector to the System.

2- Installation

2.6 Check If It Works

Once the power is supplied to the camera, it will start booting. The system will boot up to operating mode after approximately 40-60 seconds. The green LED on the Ethernet Port will flash indicating the system is ready.

Software provided on the disc called **VS Manager** allows you to check the IP address and other network details of the camera. Please refer to the VS Manager manual for instructions on how to find the IP address of the camera and to make necessary changes.

- **Encoder LED Display**

PWR	STATUS	LINK	DATA
○	○	○	○
Red	Green Blinking	OFF	OFF

The LED's above show that the **Camera is connected but a Decoder is not**. Once an Encoder is connected to a Decoder, the color of the "LINK" LED Display will turn green and the "DATA" LED will blink as video or audio transmissions occur.

- **Decoder LED Display**

PWR	STATUS	LINK	DATA
○	○	○	○
Red	Green Blinking		OFF

These LED's above show that the **Decoder has started without connecting to an Encoder**. Once an Encoder is connected, the color of "LINK" LED Display will turn green and the "DATA" LED will blink as video or audio data transmissions occur.

2- Installation

- **Description of LED**

System Status can be monitored with the LED Display:

LED	State	Description
PWR	OFF	Power OFF
	Red	Power ON
STATUS	Green Blinking	Normal Operation
	Red	System Failure: Needs Diagnostics
	Constant Change between Red and Green	NTSC/PAL setting does not match with Input Video Signal
	Red Blinking	Failed to obtain IP Address in DHCP Mode
	Constant Change between Green Blinking 2 Times and Red Blinking Once	Failed to Register on DDNS Server
	Green Blinking, Red Blinks Once every 5 Seconds	Video Loss in Encoder System
	Constant Change between Green, Orange, and Red	Formatting USB Storage Device
LINK	OFF	No Connection to Remote System
	Green	Connected to a Remote System
	Red Blinking	Decoder Only: trying to connect to an Encoder
	Orange	Illegal Connection (unsupported combination of system modes)
DATA	Green	Data Transmission in Progress
	Red	Data Loss
	OFF	No Data Transmission

3-System Operation

3.1 Remote Video Monitoring

There are two ways to monitor video when the Center System and Video Server are connected. In order for a proper operation, an IP Address must be set accordingly. Please refer to the **VS Manager Manual** enclosed with product for further details.

Default ID: admin	Default Password: 1234
--------------------------	-------------------------------

Video Monitoring with Decoder System

Once the Encoder IP Address is set in the Remote IP Address section of the Decoder, the Decoder System will connect to the Encoder System and start receiving the video images. Normally, a monitor connected to the Decoder will display video images.

Video Monitoring using Internet Explorer

If the Video Server's IP Address is entered on Internet Explorer, the system will ask for confirmation to install Active-X Control. Once authorized, Internet Explorer will start to display video images from the Encoder as shown below:

Default IP Address : http://192.168.10.100

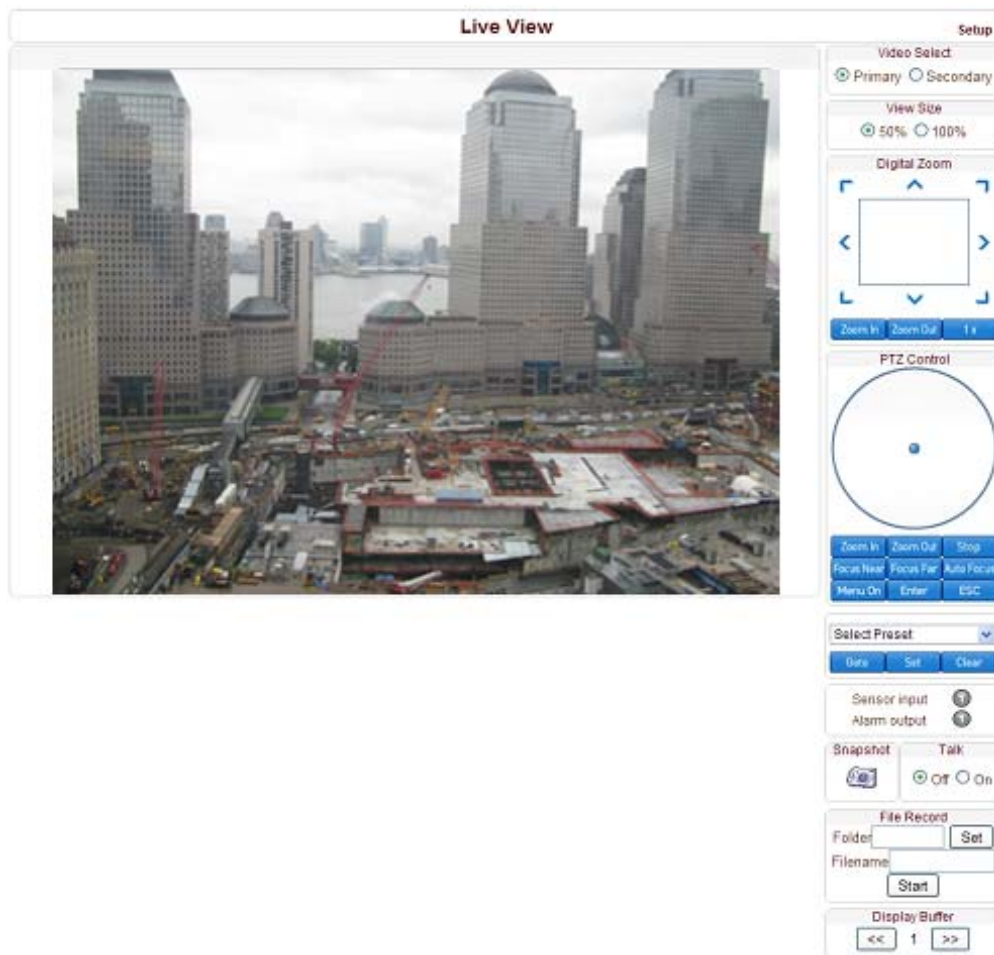

3-System Operation

- **Video Select**

Select the Video Stream to be viewed: **Primary** or **Secondary**

This camera is capable of **Dual Streaming**; Primary Streaming and Secondary Streaming. Video will be displayed according to the resolution set on video configuration. If Dual Streaming ("**Use Dual Encode**" **Menu in Video page**) is not activated, Secondary Videos are not available.

- **View Size**

Adjust the Screen Size. Screen size is initially adjusted according to the **Compression Resolution**. If you click 50% icon, the whole screen size will be reduced to half size.

- **Digital Zoom**

Control the Digital Zoom on the screen. The more the camera zooms in, the smaller the square of control panel is. Position of the image can be changed by moving position of the square. If you press "**1x**", the screen will return to the normal size.

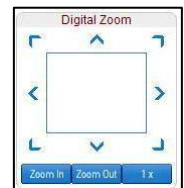

- **PTZ Control (Optical Zoom & Digital Zoom Built-In Camera)**

PTZ Control Panel is used for controlling External PTZ devices when the External PTZ devices are connected through a special Serial Port. It is possible to make zooming control by **Zoom IN / OUT** buttons on the PTZ Control Panel. In order to use Digital Zoom, select **Digital Zoom "ON"** in the **Camera Tab**)

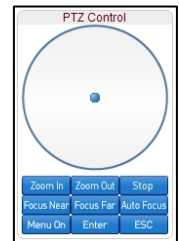

- **"Stop"**
Stop on-going PTZ action.
- **"Focus Near", "Focus Far", "Auto Focus"**
Adjust the focus of the lens.

- **Select Preset**

Set preset position and move to the specific preset position.

- **GoTo**: After set up, move to the selected preset entry.
- **Set**: Set the current position to the selected preset entry.
- **Clear**: Delete the selected preset entry.



- **Sensor Input**

Displays the status of the sensor in real time. This camera supports **One Sensor Input**. When the sensor of the camera is working, the sensor light turns red.

3-System Operation

- **Alarm Output**

Operate the Alarm Device by pressing the number icon. This camera supports **One Alarm Output**. A number icon indicates the status of the alarm device.

- **Snapshot**

Capture Video Images and save them as BMP or JPEG files.



- **Talk**

Transfer Audio from the PC microphone to the camera.

- **File Record**

Recording to an AVI file on Live View page is available. AVI files are generated in the specified folder or in specified file name on the PC where the web browser is running.

1. Press **“Set”** button to select folder or create a new folder. Enter the file name on Filename field.
2. Press **“Start”** button to start recording.
3. Press **“Stop”** button to end recording.
4. AVI file named **“IP address_hh_mm_ss”** or

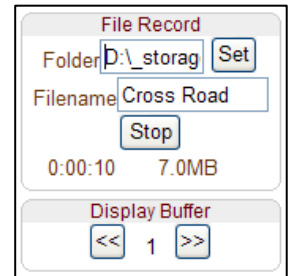

“File name_IP address_hh_mm_ss” will be generated in the specified folder depending on whether the path specified a folder or a prefix of the file name.

- **Display Buffer**

Set the number of video frames to be buffered before being displayed on web browser. Larger values result in smoother video by sacrificing the latency. A setting of 10 ~ 15 frames can be generally used for most situations.

3-System Operation

3.2 Initialization of IP address

If a System IP Address is lost, the system can be reset to the System Default IP Address using the Reset Button in the back side of the system.

1. While system is in operation, press the reset button for more than 5 seconds.
2. The system will reboot automatically.
3. Once the system reboots, IP Address will be set to the System Default as below:

• IP Mode	Fixed IP	• IP Address	192.168.10.100
• Subnet Mask	255.255.255.0	• Gateway	192.168.10.1
• Base Port	2222	• HTTP Port	80

4-Remote Configuration

Remote Setting is available by using Web Browser. Enter IP Address of the Camera and a live view screen appears (see below). Press the **Setup** button located in the upper right area of the monitoring screen for Server Setup. For Remote Setting, the user should have manager level authority or higher.

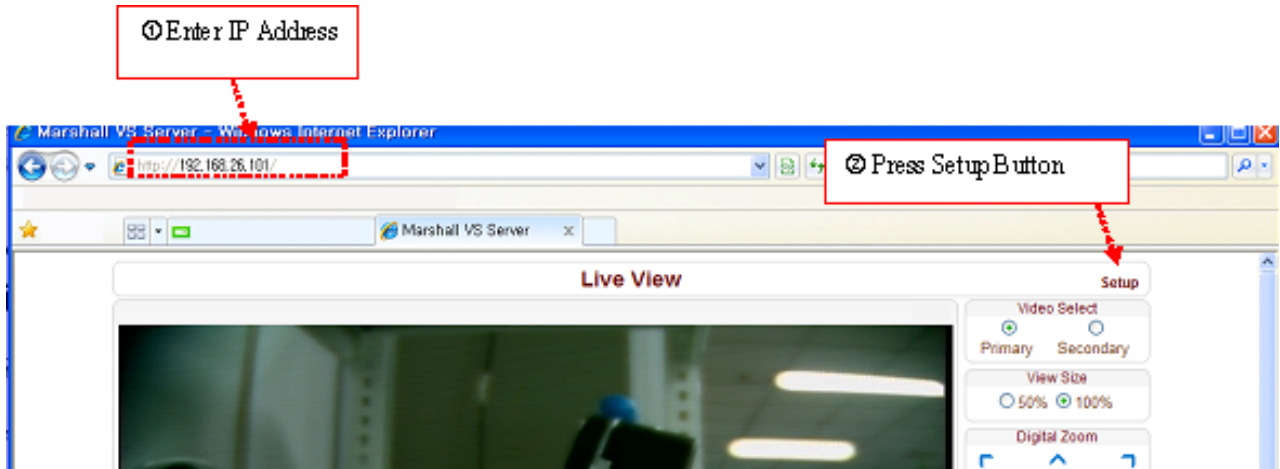

The remote configuration window may be slightly different depends on the System Modes (Encoder, Decoder). The general explanation of the configuration in this manual is based on the Encoder System and differences according to the modes will be clarified when needed.

The configurations are grouped into 10 categories: **System, Video, Audio, Network, Serial, Event, PTZ, Record, User and Camera**. Any configuration changes are not applied until "**Apply**" Button is pressed. Leaving the page without pressing "**Apply**" will discard any changes made.

4- Remote Configuration

4.1 System Configuration

Setup Live View

SystemVideoAudioNetworkSerialEventPresetRecordUser

System

General

System Mode

System ID

BurnIn OSD System ID (alphanumeric characters only)

Language

Firmware

Version

Board ID

Upgrade

Config Backup&Restore

Backup

Restore

Time

Start Time

Current Time

Time Format

Time Zone

Automatically synchronize with NTP server

NTP Server Name

Reboot

Factory Reset

4- Remote Configuration

General

- **System ID**

Enter System ID which is used as the **Camera Title Name**. The set System ID is displayed with Video Image on the Web Browser. The System ID is also transferred to and displayed on the remote software, such as VMS.

- **Burn In OSD System ID**

Burn In OSD System ID specifies the string to be inserted into the Video Image before encoding. Only alphanumeric and blank characters are allowed. Position and size can be configured on this section of the Video Page.

- **Language**

Select the Language to be used for Web-Based Configuration.

Firmware

- **Firmware Version**

Display the Current Firmware Version.

- **Board ID**

Display the Network Board ID of the Camera recognized by system.

- **Upgrade**

Upgrade Firmware:

1. Press the **Browse** Button to select a Firmware File from PC.
2. Press the **Firmware Upgrade** Button to start the upgrade.
3. Messages to show status (“Downloading” / “Upgrading”) will be displayed.
4. The camera will reboot automatically after completing the upgrade.

Do not turn off the camera during upgrading.



Now, Upgrading... Please wait a minute.

Config Backup & Restore

- **Backup**

All the settings of the configuration can be saved and stored.

4- Remote Configuration

- **Restore**

Stored configuration can be browsed and restored. The server is rebooted once the **Config Restore** Button is pressed.

Time

- **Start Time**

The most recent Camera Booting Date and Time.

- **Current Time**

Enter a New Date and Time and press the **Set Current Time** Button to update.

- **Time Format**

Change the time format. Selectable time formats are listed below:

- YYYY/MM/DD hh:mm:ss (Ex. 2010- 4-11 18:18:42)
- DD/MM/YYYY hh:mm:ss (Ex. 11- 4-2010 18:18:42)
- MM/DD/YYYY hh:mm:ss (Ex. 4-11-2010 18:18:42)

- **Time Zone**

Select Time Zone of the location where the camera is installed. Depending on the time zone, **Daylight Savings Time** will update automatically.

A **Time Zone** is a region of the earth that has uniform standard time, usually referred to as the **Local Time**. By convention, time zones compute their local time as an offset from UTC (Coordinated Universal Time). In casual use, GMT (Greenwich Mean Time) can be considered equivalent to UTC. Local time is UTC plus the current time zone offset for the considered location.

- **Automatically Synchronize with NTP Server**

Synchronize the Camera Time with an NTP Server using NTP (Network Time Protocol). The Name of the NTP Server should be registered to the Server.

The **Network Time Protocol (NTP)** is a protocol for synchronizing the computer system clocks in packet-switched, variable-latency data networks. It is designed particularly to resist the effects of variable latency by using a jitter buffer.

Reboot

- Reboot the Camera. Do not press the **Reboot Button** unless server needs a reboot.

Factory Reset

- All Settings including user accounts and logs are cleared.

Factory Reset except Network Settings

- All the Settings except for Current Network Settings are changed to Default Values.

4- Remote Configuration

4.2 Video Configuration



4- Remote Configuration

Encode

- **Enable Preview**

1. Select **ON** to enable to **Display Video** on the monitor that is connected to the Composite or HD-SDI Video Port.
2. Select the **Output Format** according to the end of the Video Page. When Enable Preview is ON, Dual Streaming is not available. When the video is transmitted directly to the monitor through BNC cable, the video does not go thorough network and encoding. Therefore, there is less delay and no effect from network limitation.

- **Input Format**

Choose Video Type to be used between **Composite NTSC** or **Composite**.

- **Input De-Interlace**

De-Interlace Function is activated if **ON** is selected.

- **Resolution**

Select Video Encoding Resolution. **Scaling** Option is used when Encoding Resolution is different from Input Resolution. Without Scaling Option, Input Video will be cut according to Encoding Resolution. On the other hand, if Scaling is selected, Input Video will be adjusted according to Encoding Resolution.

- **Frame Rate**

Determine the maximum number of frames per second for the Video Stream. 1, 2, 3, 4, 5, 6, 8, 10, 15, 20, 25 and 30 frame rate can be selected. The Actual Frame Rate of Video can be less than the maximum Frame Rate Set due to the Network Bandwidth Limitation.

- **Preference**

Select **Encoding Mode** to control Video Quality or Bit Rate: **Video Quality (VBR)** or **Bit Rate (CBR)**. If Bit Rate is selected, the Video Encoding will be affected by the Bit Rate Value entered. Therefore, Bit Rate Mode corresponds to CBR (Constant Bit Rate) Encoding. If Video Quality is selected, the Video Encoding will be affected by the quality of image selected. Therefore, Quality Mode corresponds to VBR (Variable Bit Rate) Encoding.

- **Quality**

Select Video Quality. 7 levels are available. Quality Mode (VBR Encoding) encodes every frame in a constant quality. Therefore, resulting Bit Rate may vary depending on the complexity or activity changes in the Input Video. Quality Mode is preferred when Constant Video Quality is required and Network Bandwidth is sufficient for streaming of a highly varying Bit Rate.

4- Remote Configuration

- **Bit Rate**

Determine Bit Rate value between 32 ~ 10240kbps. Bit Rate Mode (CBR Encoding) allows you to set a Fixed Target Bit Rate that consumes a predictable amount of Bandwidth. In order to stay within the Bit Rate limit, Video Quality is controlled dynamically according to the complexity or activity changes in the Input Video.

- **I-Frame Interval**

Determine I-Frame Interval between 1 and 255.

- **H.264 Profile**

Select H.264 Profile: **High Profile** or **Baseline Profile**

The standard defines various capabilities which are referred to as Profiles; targeting specific classes of applications.

- **High Profile (HiP)**

The primary profile is for broadcast and disc storage applications; particularly for high-definition television applications (For Example: this is the profile adopted by the [Blu-Ray Disc](#) Storage Format and the [DVB](#) HDTV Broadcast Service).

- **Baseline Profile (BP)**

Primarily for low-cost applications that require additional data loss robustness, this profile is used in some videoconferencing and mobile applications. This profile includes all features that are supported in the Constrained Baseline Profile, plus three additional features that can be used for loss robustness (or for other purposes such as low-delay multi-point video stream compositing).

Dual Encode

- **Use Dual Encode**

1. Select the **OFF** button on the **Enable Preview** to enable the Dual Encoding.
2. Select the **ON** button on the **Use Dual Encode** to enable Dual Encoding.

The Secondary Video can be viewed on the **Live View** window by selecting **Secondary** on **Video Selection**.

- **Dual Encode Algorithm**

Select **H.264** or **MJPEG** for the **Secondary Streaming**. With H.264, either **Bit Rate Mode** or **Quality Mode** can be selected for the Preference Mode. MJPEG supports **Quality Mode** only.

Motion Detection

- **Use Motion Detection**

Determine if the **Motion Detection** function will be used.

4- Remote Configuration

- **Motion Detection Area Editing**

Configure regions to apply motion detection. Regions of arbitrary shape can be configured by the following steps:

- ① Select **Enable** in the **Edit Menu**.
- ② In the **Mode Menu**, select **Set** to include cells in the motion detection region and select **Erase** to excluding them.
- ③ **Select Cells** by right clicking the mouse and dragging selection box until desired area is highlighted.
- ④ Press **Apply Edited Area** to save the selection.



- **Sensitivity**

Sensitivity is the level of movement that triggers the motion detection function. This value determines the sensitivity of motion within a block; the smaller the number, the more sensitive the motion detection becomes. Sensitivity ranges from 0 to 10.

Information Display

System ID and/or Server Time can be displayed over the video window in the Internet Explorer Browser. Items can be turned on or off individually and the position also can be configured. This information will be displayed **after the video is decompressed**.

4- Remote Configuration

Burn In OSD

Insert System ID and Date/Time in the **Compressed Video**. System ID and Time respectively can be turned on or off in the video. Position and Font size can be configured also. System ID for Burn In OSD exists independently from the Normal System ID. The size of the Burn In OSD display varies according to the encoding resolution setting. This is inevitable because the Burn In OSD is inserted to the frames before encoding is performed. The following table describes the rule for Burn In OSD Display:

Resolution	Small (8x8)	Middle (16x16)	Large (32x32)
352x480 / 352x240 / 352x576 / 352x288	2	1	0
720x480 / 720x240 / 720x576 / 720x288 / 640x480 / 800x600	2	2	1
1024x768 / 1280x720 / 1280x960 / 1280x1024 / 1440x900 / 1600x900/ 1680x1050 / 1920x1056 / 1920x1080 / 2048x1536 / 2560x1600 / 2592x1936	2	2	2

2: Both System ID and Time are displayed.

1: Either System ID or Time can be displayed. When both are enabled, the System ID is displayed.

0: No items are displayed. This is because video area is too small to display OSD text in large size.

Output Format

Output Format Menu appears only when **Enable Preview** is **ON**. Select the output format for the monitor preview according to the video output and monitor specification.

4- Remote Configuration

4.3 Audio Configuration

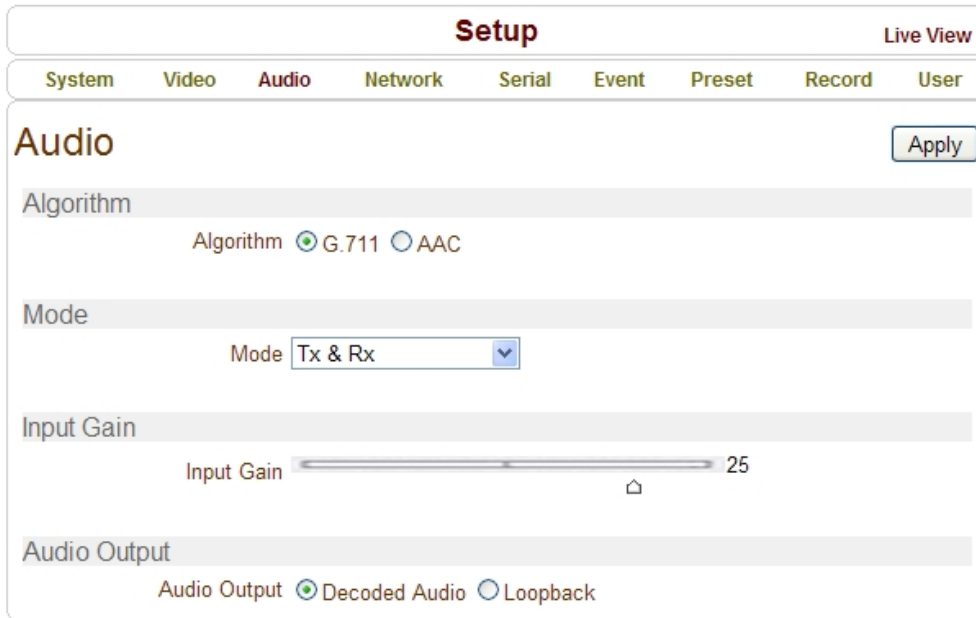

Algorithm

- **Algorithm**

Select the Audio Algorithm: **G.711** or **AAC**. G.711 and AAC supports client to server side direction. Bi-directional audio communication is supported as well.

- **Bit Rate**

Select the Bit Rate between 64Kbps and 128kbps when AAC is selected. The Sampling Rate is fixed at 8KHz and 32KHz for G.711 and AAC respectively. When a Camera is connected to a Decoder, the Decoder's Audio Algorithm should be set identically to transmit audio properly.

Mode

- Select Audio Operation Mode:

Mode	Action
Off	No Operation
Tx-Only	Transmit Only
Rx-Only	Receive Only
Tx & Rx	Transmit and Receive

4- Remote Configuration

Input Gain

- Set Audio Input Gain from 0 to 31.

Audio Output

Configure the Audio Source to be played on Audio Output Port.

- **Decoded Audio:** Audio Stream from client is played.
- **Loopback:** Audio Data from the Audio Input Port is looped back to the Audio Output Port.

4- Remote Configuration

4.4 Network Configuration

Setup Live View

SystemVideoAudioNetworkSerialEventPresetRecordUser

Network

Apply

Local

IP Mode

Local IP

Local Gateway

Local Subnet

DNS

Obtain DNS server address automatically

Use the following DNS server addresses

Primary DNS Server

Secondary DNS Server

IPv6

IPv6 Address

IPv6 Subnet Prefix Length

IPv6 Default Gateway

IPv6 LinkLocal

Port

Base Port (1025~65535)

HTTP Port (80, 1025~65535)

HTTPS Port (443, 1025~65535)

RTSP Port (554, 1025~65535)

Discovery

UPNP Off On

Zeroconf Off On

WS Discovery Off On

Authentication

RTSP Authentication Off On

HTTPAPI Authentication Off On

One-way Streaming

Mode

SNMP

SNMP Listen port (0, 161, 1025~65535)

SNMP Trap Destination IP

SNMP Trap Destination Port (0, 162, 1025~65535)

Multicast

Multicast IP (224.0.0.0 ~ 239.255.255.255)

DDNS

DDNS Server None TrueDNS DynDNS Vdyn

Check IP Disable

Bitrate Control

Flow Control Mode

IP Filtering Setup

IP Filtering Setup

Address Information

Current IP

Current Domain

MAC Address

Connecting

4- Remote Configuration

Local

- **IP Mode**

Select the IP Mode: **Fixed IP** or **DHCP** (Dynamic Host Configuration Protocol). Depending on the selected mode, further configuration is provided below:

IP Mode	Selection	Description
Fixed IP	Local IP	Fixed IP Address
	Local Gateway	Gateway IP Address
	Local Subnet	Subnet Mask
DHCP	N/A	

Note: IP Address can be requested from ISP provider or Network Manager.

DNS

- **Obtain DNS Server Address Automatically**

Get DNS Server Address automatically when IP Mode is DHCP.

- **Enter the following DNS Server IP Address:**

- Primary DNS Server
- Secondary DNS Server

The screenshot shows a configuration interface with the following sections:

- DDNS:** Radio buttons for "None" (selected), "DynDNS", and "Vdyn". A checkbox for "Check IP Disable" is present and unchecked.
- Bitrate Control:** A dropdown menu for "Flow Control Mode" set to "Frame Drop Mode".
- IP Filtering Setup:** A button labeled "IP Filtering Setup".
- Address Information:** Fields for "Current IP" (192.168.10.100), "Current Domain" (Not RegisteredB), "MAC Address" (00:1C:63:A6:0C:C9), and "Connecting" (1 :: 192.168.10.222 - (1,0)).

Domain Name System (DNS) is a database system that translates a computer's fully qualified domain name into an IP address. Networked computers use IP addresses to locate and connect to each other, but IP addresses can be difficult for people to remember. For example, on the web, it's much easier to remember the domain name `www.amazon.com` than it is to remember its corresponding IP address (207.171.166.48). Each organization that maintains a computer network will have at least one server handling DNS queries. That server, called a name server, will hold a list of all the IP addresses within its network, plus a cache of IP addresses for recently accessed computers outside the network.

4- Remote Configuration

Ipv6

- **Ipv6 Address**

Enter the designated Ipv6 Address.

- **Ipv6 Subnet Prefix Length**

Enter the bit number of Ipv6 Subnet.

- **Ipv6 Default Gateway**

Enter the designated Ipv6 Gateway.

- **Ipv6 Link Local**

Display Ipv6 Link Local.

Port

- **Base Port (1025 ~ 65535)**

Enter the Base Port Number. **Network Base Port** is used for communication with remote clients. In order for camera's decoders to connect to remote systems (For Example: Decoder, VMS, NVR Software), the Port Number must be configured identically on the camera /encoder side and client /decoder side.

- **HTTP Port (80, 1025 ~ 65535)**

Enter HTTP Port used for Web-Based Connection

- **HTTPS Port (443, 1025 ~ 65535)**

Enter HTTPS Port used for Secured HTTP Connection.

- **RTSP Port (554, 1025 ~ 65535)**

Enter RTSP Port used for RTSP-Based Connection. The default RTSP port is 554 **RTSP** (Real Time Streaming Protocol) is a standard for media streaming between server and client.

Discovery

- **UPNP**

When UPNP is **ON**, it allows the discovery by the client according to UPNP (Universal Plug and Play) protocol.

- **Zeroconf**

When Zeroconf is **ON**, it allows the discovery by the client according to Zeroconf protocol.

- **WS Discovery**

Discovery function based on Web Service is enabled. It allows the discovery by Client SW which is supporting Onvif.

4- Remote Configuration

Authentication

- **RTSP Authentication**

If **RTSP Authentication** is **ON**, user in the client side is asked to enter User ID and Password.

- **HTTP API Authentication**

When **HTTP API authentication** is **ON**, HTTP Authentication is asked for all clients that use HTTP API.

One-Way Streaming

- This Server provides two kinds of one-way streaming based on UDP to clients: **RTP** and **MPEG-TS**. Both types of transmission do not provide back change commands from this client (decoder).

- **RTP (Real-Time Transport Protocol)** is an Internet Protocol used for transmitting single real-time multimedia data such as audio and video to a select group of connected clients. Normally, **RTSP** uses **RTP** to format packets of multimedia content. RTP menu is used when the RTP is streaming without the RTSP Connection. RTP stream will be transmitted to the destination set. The **SDP** (Session Description Protocol) file can be found in the server and the client can retrieve it by using http connection. See settings below:

- **Destination IP:** Set the IP Address of the destination system receiving the RTP stream. If the system is a decoder, RTSP authentication information must be entered in the RTSP URL:

rtsp://**admin:1234**@192.168.10.100:554/video1

- **Destination Port:** Set the Destination Port to receive RTP Stream.

- **User Name:** Enter the User Name that will be used in the SDP File.

- **File Name:** Enter the File Name that will be used for the SDP File Name.

This can be accessed through <http://ServerAddress/filename>

Mode	RTP	▼
Destination IP	192.168.10.14	
Destination Port	1026	(0, 1026~65534, Even number only)
User Name	Office	
File Name	ch0.sdp	

4- Remote Configuration

- **MPEG-TS** is a standard format for transmission and storage of audio, video, and data, and is used in broadcast systems such as DVB and ATSC. Transport Stream is specified in MPEG-2 Part 1, Systems (formally known as ISO/IEC standard 13818-1 or ITU-T Rec. H.222.0). Transport Stream specifies a container format encapsulating packetized elementary streams, with error correction and stream synchronization features for maintaining transmission integrity when the signal is degraded. As MPEG-TS itself supports only AAC as the audio algorithm, only video is streamed when audio algorithm is set to G.711. See settings below:

- **Destination IP:** Set the IP Address of the destination system which will receive MPEG-TS stream.
- **Destination Port:** Set the Port of the destination system which will receive MPEG-TS stream.

Mode	MPEG-TS	
Destination IP	192.168.10.14	
Destination Port	1026	(0, 1026~65534, Even number only)

SNMP

SNMP (Simple Network Management Protocol) is compatible to both SNMPv1 and SNMPvec. Settings for using SNMP are as follows:

- **SNMP Listen Port (0, 161, 1025 ~ 65535):** This Port is for connecting external devices when system operates as a SNMP client. SNMP is not used with a 0 value.
- **SNMP Trap Destination IP:** Set the SNMP Trap Destination IP.
- **SNMP Trap Destination Port (0, 162, 1025 ~ 65535):** Set the SNMP Trap Destination Port. SNMP is not used with a 0 value.

Simple Network Management Protocol (SNMP) is used by network management systems to communicate with network elements. SNMP lets TCP/IP-based network management clients use a TCP/IP-based internetwork to exchange information about the configuration and status of nodes. SNMP can also generate trap messages used to report significant TCP/IP events asynchronously to interested clients. For Example: A router could send a message if one of its redundant power supplies fails or a printer could send an SNMP trap when it is out of paper.

4- Remote Configuration

Multicast

- **Multicast IP**

The Multicast Menu is used for configuring the Multicast IP Address where media stream is delivered when a client's Decoder, VMS or NVR software is connected in Multicast Mode. The Multicast IP Address selection range is between 224.0.0.0 and 239.255.255.255 and can only be used when Media Protocol is set to Multicast.

DDNS

Select the DDNS (Dynamic DNS) Server to use. Only one server can be selected.

- **DynDNS:** DynDNS Service is used in this mode. Refer to www.dyndns.org for details. ID, Password and Domain Name are needed for DynDNS.

Dynamic DNS is a method, protocol, or network service that provides the capability for a networked device, such as a router or computer system using the Internet Protocol Suite, to notify a domain name server to change, in real time (ad-hoc) the active DNS configuration of its configured hostnames, addresses or other information stored in DNS.

- **Vdyn:** Vdyn is a DDNS Service provided by Visionica (<http://visionica.com>). No further configuration is required for using this service. It uses the internal MAC Address for the registration. When successful, the Domain Name of the form 001C63A607EC.visionica.info is displayed on CurrentDomain entry of Network Page. Email setting is not mandatory.
- **Check IP Disable:** If "Check IP Disable" is selected, it will skip to check its own IP. In Fixed IP Mode, the set IP will be registered on the DDNS server. In DHCP Mode, dynamically assigned IP will be registered on the DDNS server. Check IP Disable should be unchecked to obtain Public IP in the Network.

4- Remote Configuration

Bit Rate Control

When one or more clients are connected to the camera, some of the clients do not have enough bandwidth to receive the encoded stream completely. In this case, it is possible to select the stream video mode:

- **Frame Drop Mode:** Encoding is performed strictly according to video settings. When a client is connected through a network with less bandwidth, it may not receive all the frames. Frames are dropped on sending module if the network is bottlenecked.
- **Suppression Mode:** Encoding bit rate and frame rate are adjusted so frames are not lost when client network bandwidths are limited. In this case, all clients can be affected by the averaged bit rate and frame rate.

Address Information

The following network information is displayed (read only):

• **IP Filtering Setup**

- **Current IP Address:** The Camera's IP Address is useful when the camera is set to DHCP Mode.
- **Current Domain Name:** The Registered Domain Name is displayed when the camera is registered on the DDNS Server.
- **MAC Address:** The MAC Address is used for the Camera's DDNS Registration and is displayed on the DDNS Server.
- **Connecting:** Client IP Addresses that are currently connected to system are listed.

4- Remote Configuration

4.5 Serial Configuration

Setup [Live View](#)

[System](#) [Video](#) [Audio](#) [Network](#) [Serial](#) [Event](#) [Preset](#) [Record](#) [User](#)

Serial Apply

COM1 (RS-232 Port)

Protocol

Bitrate

Data Bit

Parity

Stop Bit

COM2 (RS-422/485 Port)

Protocol

Bitrate

Data Bit

Parity

Stop Bit

PTZ

PTZ Type

PTZ ID

PTZ Port

Sensor Type

Sensor 1 Off N/O N/C

Sensor 2 Off N/O N/C

Sensor Schedule

Select Sensor Off Sensor On

Sensor 1

	0	1	2	3	4	5	6	7	8	9	10	11	12	13	14	15	16	17	18	19	20	21	22	23
SUN																								
MON																								
TUE																								
WED																								
THU																								
FRI																								
SAT																								

Sensor 2

	0	1	2	3	4	5	6	7	8	9	10	11	12	13	14	15	16	17	18	19	20	21	22	23
SUN																								
MON																								
TUE																								
WED																								
THU																								
FRI																								
SAT																								

4- Remote Configuration

Serial Port Configuration

- **Serial Protocol:** Two Serial Ports are on the Video Server: **RS-232 & RS-422/485**. (For the RS-422/485 Port, select RS-422 or RS-485).
- **Serial Port Configuration:** The Serial Ports can be configured with the following options:

Mode	Selection
Bit Rate	2400, 4800, 9600, 19200, 38400, 57600, 115200 bps
Data Bits	5, 6, 7, 8 bits
Parity	NONE, EVEN, ODD bit
Stop Bit	1, 2 bit

NOTE: Each Serial Port Configuration must be the same as the Connecting Device.

PTZ

- **PTZ Type:** Select the PTZ Type: Camera or Receiver.
- **PTZ ID:** Each Camera or Receiver is assigned a Unique ID since it is possible to control multiple PTZ cameras and receivers over single control line. Enter the PTZ ID for each camera or receiver for control. The ID value ranges between 0 and 255.
- **PTZ Port:** Select the Serial Port used for PTZ Camera Control.

Sensor Type

There are Two Sensor Input Ports on the Video Server. Each Sensor Port can be configured with the following options:

Function	Operation
OFF	Not used.
NO (Normally Open)	The port is normally open and activated when closed.
NC (Normally Closed)	The port is normally closed and activated when opened.

The function of the sensor port is set based on the type of the sensor connected.

4- Remote Configuration

Sensor Schedule

- Choose **Sensor OFF** or **Sensor ON** and click the cells to make Sensor Schedule according to day of the week and hour.

- Click desired **“Cell”** to set schedule.

	0	1	2	3	4	5	6	7	8	9	10	11	12	13	14	15	16	17	18	19	20	21	22	23
SUN																								
MON																								
TUE							■																	
WED																								
THU																								
FRI																								
SAT																								

- Click desired **“Time Line”** or **“Date Line”** to set schedule.

	0	1	2	3	4	5	6	7	8	9	10	11	12	13	14	15	16	17	18	19	20	21	22	23
SUN															■									
MON															■									
TUE							■																	
WED																								
THU	■	■	■	■	■	■	■	■	■	■	■	■	■	■	■	■	■	■	■	■	■	■	■	■
FRI																								
SAT															■									

- To set cells in the schedule, click on **“Empty Cells”** below.

✓	0	1	2	3	4	5	6	7	8	9	10	11	12	13	14	15	16	17	18	19	20	21	22	23
SUN	■	■	■	■	■	■	■	■	■	■	■	■	■	■	■	■	■	■	■	■	■	■	■	■
MON	■	■	■	■	■	■	■	■	■	■	■	■	■	■	■	■	■	■	■	■	■	■	■	■
TUE	■	■	■	■	■	■	■	■	■	■	■	■	■	■	■	■	■	■	■	■	■	■	■	■
WED	■	■	■	■	■	■	■	■	■	■	■	■	■	■	■	■	■	■	■	■	■	■	■	■
THU	■	■	■	■	■	■	■	■	■	■	■	■	■	■	■	■	■	■	■	■	■	■	■	■
FRI	■	■	■	■	■	■	■	■	■	■	■	■	■	■	■	■	■	■	■	■	■	■	■	■
SAT	■	■	■	■	■	■	■	■	■	■	■	■	■	■	■	■	■	■	■	■	■	■	■	■

4- Remote Configuration

4.6 Serial Configuration

Setup Live View

SystemVideoAudioNetworkSerialEventPresetRecordUser

Event

Apply

Local

Sensor1 Beep Alarm1 Alarm2 E-mail FTP No Preset v

Sensor2 Beep Alarm1 Alarm2 E-mail FTP No Preset v

On Video Loss Beep Alarm1 Alarm2 E-mail FTP No Preset v

On Motion Beep Alarm1 Alarm2 E-mail FTP No Preset v

Remote

Sensor1 Beep Alarm1 Alarm2 E-mail FTP No Preset v

Sensor2 Beep Alarm1 Alarm2 E-mail FTP No Preset v

Sensor3 Beep Alarm1 Alarm2 E-mail FTP No Preset v

Sensor4 Beep Alarm1 Alarm2 E-mail FTP No Preset v

On Disconnect

On Disconnect Beep Alarm1 Alarm2 E-mail FTP No Preset v

Duration

Beep synchronous v

Alarm1 1sec v

Alarm2 1sec v

E-mail Notification

Server Address

Port 25 (25, 465, 1025~65535)

Sender Address

Authentication on SMTP server Off On

ID

Password

SSL Disable Enable

Destination Address

Video Clip Attaching Off Primary Video Secondary Video JPEG Capture

Number of Frame 1 (1 ~ 10)

E-mail Test

FTP Upload

Server Address

Port 21 (21, 1025~65535)

ID

Password

FTP Filename

FTP Base Directory

Upload Video Primary Video Secondary Video JPEG Capture

Number of Frame 1 (1 ~ 10)

Continuous Upload Off On

Upload Duration 10 sec (Max 300)

Upload Interval 300 sec (Max 3600)

FTP Test

4- Remote Configuration

This server has **Two Sensor Ports** and **Two Alarm Ports**. When a decoder is connected to the server, instead of a PC client, one system becomes a Local System and the other becomes a Remote System. Actions can be configured for events from the Remote System as well as for the Local System. For Example: It is possible to turn on an alarm device such as a **Local (Center) Decoder System** when a Sensor Device in **Remote (Site) IP Camera** is triggered. Local Section configures the actions for events from **Local (Self) System** and activates Local Devices, while the Remote Section is used to configure the actions for events from Remote (Peer) System.

The following table shows possible event actions:

Action	Description
Beep	Triggers Beep Port.
Alarm Out	Triggers Alarm (Relay) Port.
Email	Sends Email to the specified address. AVI file can be attached
FTP	Upload AVI File to a specified FTP Server
Preset	Move to the Preset Position

Local & Remote Event Configuration

- **Sensor1 / Sensor2**

Configure the actions when the sensor is activated. Multiple actions can be set for a single event.

- **On Video Loss**

Configure the actions when video input signal is lost. Multiple actions can be set for a single event.

- **On Motion**

Configure the actions when motion is detected. Multiple actions can be set for a single event.

- **On Disconnect**

Configure the actions when the link (connection) to peer system is disconnected. Multiple actions can be set for a single event. This event happens when the last client which has been receiving video from the camera, loses the connection.

Alarm Duration and Beep Activation

- Set the duration of alarm or beep activation for each event. If it is set to **continuous**, it will be active until it is manually reset.

4- Remote Configuration

Email Notification

Specify the information to send when email is selected as an Event Action.

- **Server Address:** Enter email (SMTP) server address.
- **Port:** Specify a port for SMTP operation. **Port 25 is the default port in SMTP operation.** If a different port is configured in the SMTP server, this port will need to be changed accordingly.
- **Sender Address:** Enter an account registered to the SMTP server.
- **Authentication for SMTP Server:** Set authentication server requirements for sending emails.
- **ID & Password:** When the server requires authentication, ID and Password of an email account needs to be entered.
- **Destination Address:** More than one address can be used by entering delimiting comma (,) or semi-colon (;). Destination address maximum is 63 characters.
- **Video Clip Attaching:** Video clip stored at the moment of event can be attached as an AVI or JPEG file format. When dual encoding is enabled, **Primary Video**, **Secondary Video** (H.264 only) or **JPEG Capture** can be selected. The duration of video clip can be configured with **Pre-Event Time** and **Post-Event Time** in **Event Record** section.
- **Number of Frames:** The number of JPEG frames can be configured. This setting is applicable only when **JPEG Capture** is selected.
- **Email Test:** Email sending can be tested with this button. The configured settings should be saved first by pressing the “**Apply**” button before using the Email Test function. One of the following messages will be sent as a result of the test:

4- Remote Configuration

Message	Description
Email Sent Successfully	Test email has been sent successfully. Reception can be checked with client.
Failed Connection to SMTP Server	Connection to the SMTP server failed. It is necessary to check if the server is reachable and server address and port are correct.
Authentication Failed	The server is reachable but authentication failed. ID and/or password need to be checked.
SMTP Server Rejected Mail	The server is reachable, but email failed due to a reason other than authentication. This error happens often when the server authenticates according to its own rule. For Example: The IP address of a specific range or specific suffix is allowed.

FTP Upload

Specify the information to upload when FTP is selected as an Event Action.

- **Server Address:** Enter the FTP server address that will receive video files.
- **Port:** Specify a port for FTP operation. Port 21 is the default port in FTP operation. If a different port is configured in the FTP server, this port needs to be changed accordingly.
- **ID & Password:** Enter ID and Password to access the FTP server.
- **FTP File Name:** The files uploaded to the FTP server can be named by the user. If a fixed name is specified, the file is overwritten. File name maximum length is 60 characters. If the name is left blank, file name is determined according to the internal rule implemented in the firmware. The following macros are supported to form variable parts of file names. The strings are case-sensitive.

%YYYY: year

%MM: month

%DD: day

%hh: hour

%mm: minute

%ss: second

%EVENT: event type (Sensor1, Motion, ...)

%ADDR: server address (Domain Name when DDNS is used; otherwise IP Address)

“.avi” or “.jpg” will be automatically added at the end of filenames depending on the type of video file.

4- Remote Configuration

- **FTP Base Directory:** Specify the name of the directory to be created in the FTP server. It is valid only when **Use Record** is set to **Use FTP on Record Session**.
- **Upload Video: Primary Video** and **Secondary Video** (H.264 only), **JPEG Capture** can be selected for uploading. The duration of video clip can be configured with **Pre-Event Time** and **Post-Event Time** in **Event Record** section.
- **Number of Frame:** Enter frame number of JPEG Capture (from 1 to 10).
- **Continuous Upload:** Continuous upload '**ON**' allows video clips to be transmitted regularly regardless of event occurrences. When this mode is turned ON, FTP upload is suppressed.
- **Upload Duration:** Specify recording duration of a video clip to be transmitted. (Max 300 sec).
- **Upload Interval:** Specify transmission interval. (Max 3600 sec). Upload Duration is not included in Upload interval. For example, if Upload Interval is 60 seconds and Upload Duration is 20 seconds, a video clip for 20 seconds is transmitted every 80 seconds.
- **FTP Test:** FTP upload function can be tested with this button. Please note that configured settings should be saved first by pressing **Apply** button before using FTP Test function. One of the following messages will come as a result of the test:

Message	Description
FTP Connection Tested Successfully	The connection to the FTP server is successful.
Failed to Connect FTP Server	The connection to the FTP server failed. It is necessary to check if the server is reachable and server address and port are correct.
Authentication Failed	The server is reachable but authentication failed. ID and/or Password needs to be checked.
Failed to Upload File	File upload failed. The user of the ID is not allowed for writing into the directory or FTP server can be full.
Failed to Erase File	Failed to delete the test file. The user of the ID doesn't have the privilege for file deletion.

4- Remote Configuration

4.7 Preset Configuration

(When configuring a Marshall IP Camera or using the IP Camera as a Video Source)

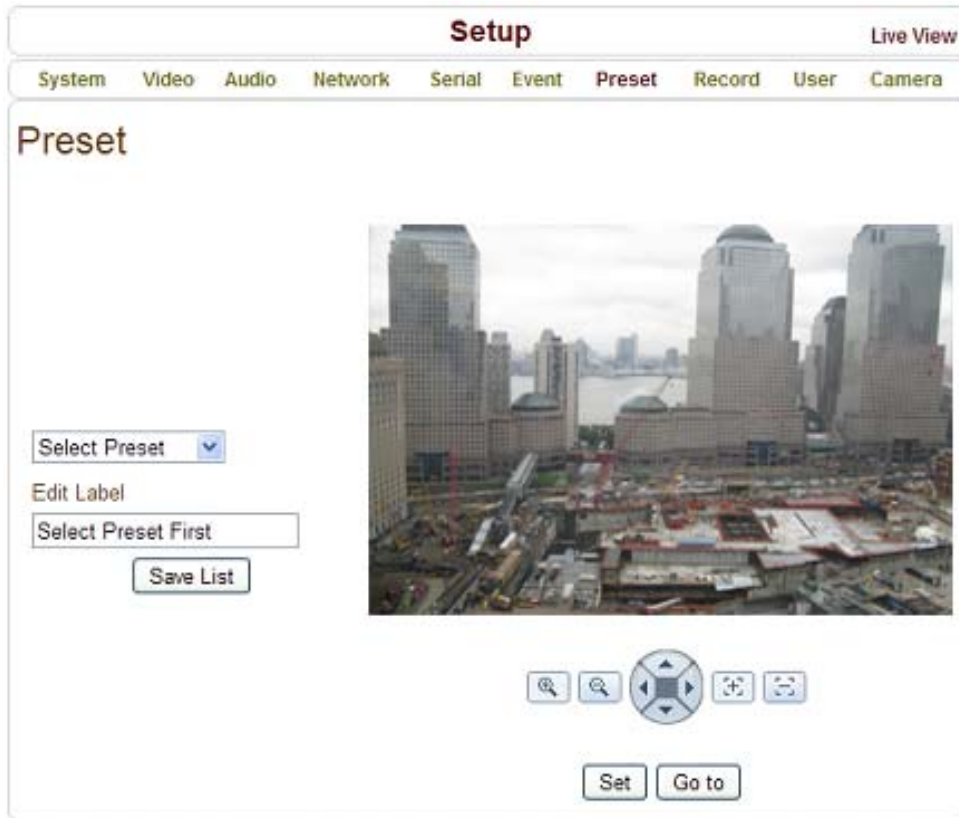

Preset

- Select preset # and insert the name of preset.
- Set camera position for the preset and press **Save List** button.

4- Remote Configuration

4.8 Record Configuration

Live View
Setup

System
Video
Audio
Network
Serial
Event
Preset
Record
User

Record
Apply
Search Page

Disk Information

No disk

Disk size : ---

Free space : ---

Refresh

General

Use Record Off Use Disk Use FTP

Select Video Primary Video Secondary Video

Manual Record Off On

Overwrite Off On

Max File Size

Max File Length

Automatically Backup to FTP Off On

Erase after Backup Off On

Start Time of Backup Data

Event Type

Event Type 1 Sensor1 Sensor2 Motion Video Loss

Event Type 2 Sensor1 Sensor2 Motion Video Loss

Event Type 3 Sensor1 Sensor2 Motion Video Loss

Event Type 4 Sensor1 Sensor2 Motion Video Loss

Pre-event Time

Post-event Time

Schedule Table

Record Off Continuous Disconnect

Select Event Type 1 Event Type 2

Event Type 3 Event Type 4

	0	1	2	3	4	5	6	7	8	9	10	11	12	13	14	15	16	17	18	19	20	21	22	23
SUN																								
MON																								
TUE																								
WED																								
THU																								
FRI																								
SAT																								

4- Remote Configuration

DISK

SD memory can be used; at least 1GB size is recommended. Options are EXT3 or FAT32 file system. A disk with either EXT3 or FAT32 file system can be read in Linux PC. However, only disk with FAT32 file system can be read in Windows PC.

Less than 4Mbps of video bit rate is recommended when you record and monitor video simultaneously since frame dropping may happen due to performance limitation.

Disk Information

Be sure to restart the system after connecting an SD card. During booting, the system reads status of disk and initializes it. Once the initialization of a disk is finished, the status of disk is shown on **Record** Page of Web-Based Setup.

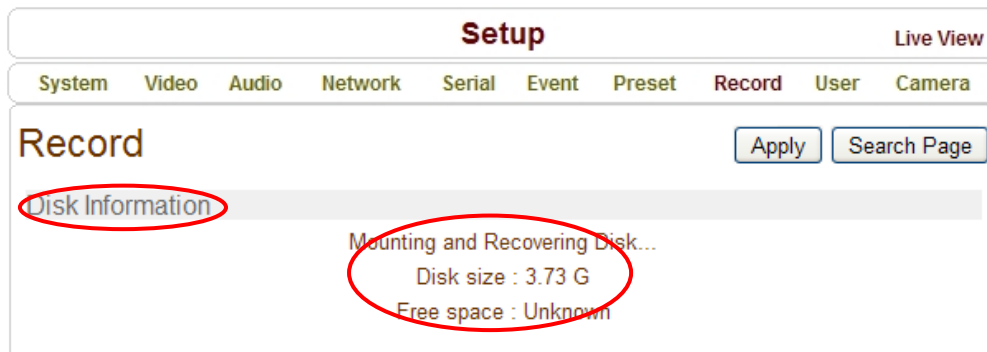

4- Remote Configuration

Refer to the Chart for Checking Disk Status:

Disk Status	Description
Disk Error Detected	Error
No Disk	Disk is not connected to the system.
Searching Disk information	Checking the status of disk. Refresh the page and wait until the status is changed.
Mounting and Recovering Disk	Performing recovery process when disk damage is found. It takes from seconds to minutes for recovering.
Disk Format Needed	Disk is attached, but the type of the file system is unknown or damaged.
Unknown Disk Type Detected	
USB Disk Available	Available to be used for recording
Disk Removed or in Abnormal State	Disk is detached during operation or there is damage on the file system. If it happens while disk is connected, it is recommended to format the disk.

General

- **Use record**
 - **OFF**: Recording function will not be used when “**OFF**” is selected
 - **Use Disk**: Recording will be enabled and data will be written to a disk
 - **Use FTP**: Recording will be enabled and data will be uploaded to an FTP server. In this mode, FTP upload by event is automatically disabled.
- **Select Video**
Select video stream to record.
- **Manual Record**
When “**ON**” is selected, record is operated regardless of schedule.

4- Remote Configuration

- **Overwrite**

When the disk becomes full, the oldest data are deleted automatically. It is valid only when **Use Record** is set to **Use Disk**.

- **Max File Size/Max File Length**

Max File Size option is for limiting the size of AVI file. If small file size is set, files of small size will be generated but numbers of the files will be increased. **Max File Length** option is for limiting the time length of AVI file. If the size of a file becomes **Max File Size** or the duration of the recording reaches **Max File Length**, a new file is created.

- **Automatically Backup to FTP**

Data recorded in the disk can be uploaded to an FTP server automatically for backup. FTP server is configured on Event page. It is valid only when **Use Record** is set to **Use Disk**.

- **Erase After Backup**

Data are deleted in the disk automatically after being uploaded to the FTP server. It is valid only when **Automatically Backup to FTP** is used.

- **Start Time of Backup Data**

Specify the time of the data in the disk from which Backup to FTP Disk is performed. This time is changed automatically as the backup to FTP server goes. So it is useful to check current backup status. It is valid only when **Automatically Backup to FTP** is used.

- **FTP Base Directory**

Specify the name of the directory to be created in the FTP server. It is valid only when **Use Record** is set to **Use FTP**.

Event Type

Three recording modes are supported: **Continuous**, **Event**, **Disconnect**. In case of Event recording, event types can be selected among several events. Selected event type is used for configuring the schedule table. Up to 4 event types can be configured and each event type can be a combination of sensor, video loss and motion event.

- **Pre-Event Time**

Specify the duration of recording before an event happens.

- **Post-Event Time**

Specify the duration after the event is cleared.

4- Remote Configuration

Schedule Table

Actual Recording Mode is determined by **Schedule Table** where recording mode is configured by day (of a week) and hour.

Operation of each Recording Mode as follows:

- **Record OFF:** No recording.
- **Continuous:** Records continuously.
- **Disconnect:** Recording is started when the system loses the connection to its last client (Decoder, VMS/NVR) etc. When there are multiple clients and one of the client is disconnected, this doesn't happen.
- **Event Type:** Records when an event configured in **Event Type** setting happens.

Checking Status of Recording

Recording status can be checked on the main view page.

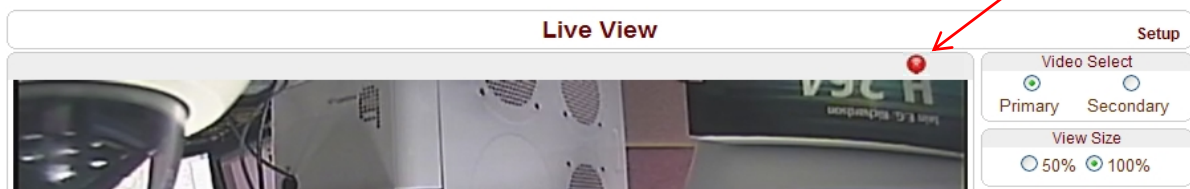

Search and Playback

Recorded video and audio data can be saved as AVI format in the disk. In general, one AVI file is created for an event in case of event-based recording. However, it is possible that recorded data by serious of events happening continuously can be merged to a single AVI file depending on pre/post event time setting. The size of file is limited to 10 ~ 200MB or 10 minutes. In case of continuous recording, AVI files are created in series and the size of each is limited to 10 ~ 200MB or 10 minutes.

• Search

Actual recording of a file currently being recorded doesn't appear until it is completed. In case of Continuous recording, a file will be shown after 10 minutes from the start of recording, for a file is generated every 10 minutes.

1. Press **Search Page** button on the **Record** setup page. Dates with recording data will be shown as follows:



2. First, choose the date for search and the list of AVI files will be shown.
3. The file name shows the date and time: **"Date Begin Time End Time.avi"**.

4- Remote Configuration

4. Press **Root** to move back to the page with date list.



- **Playback**

1. Selecting an AVI file will show a dialog for opening or saving the file.

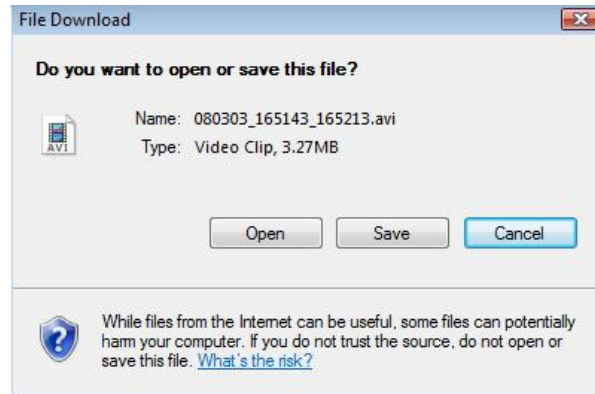

2. Pressing **Save** button, the file will be stored in the PC. The AVI file can be played with Windows Media Player.

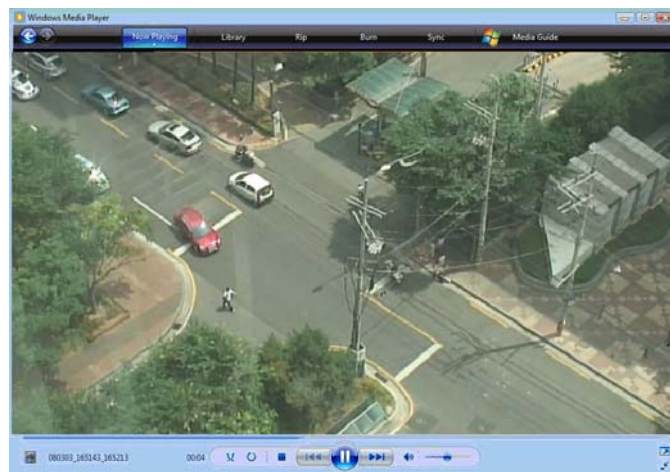

4- Remote Configuration

3. If you press **Open** in the dialog, the file will be downloaded and played automatically with Media Player.

4. Another connection through web is disabled during downloading and it is also not allowed to download two AVI files at the same time.

- **Deletion of Data**

1. If you want to delete recorded files, select the files by checking the item in front of each file and press **Delete** button.

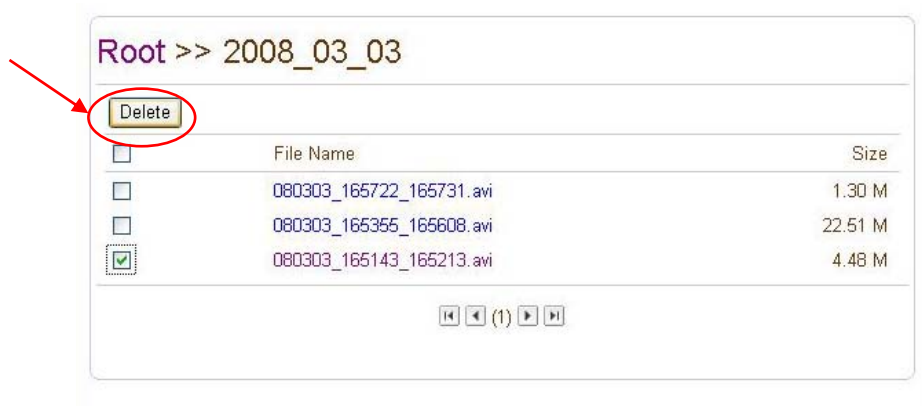

2. It is possible to delete multiple files at once.

4- Remote Configuration

4.9 User Configuration

Setup Live View

System Video Audio Network Serial Event Preset Record **User** Camera

User

User List

ID	Privilege Level	
admin	Admin	<input checked="" type="radio"/>

Login Policy

Skip Login Disable Enable

Privilege Level After Login Skipped Admin

User List

- User can be registered and privilege level user can be specified. Admin User can set User Configurations. Max of 16 Users can be registered and each user can have one of four privileges.

Privilege	Allowed Operations	Remarks
Admin	All operations	User ID = admin
Manager	All operations except for user configuration	
User	Live viewing and PTZ control	
Guest	Live viewing only	

• Add User

Press **Add** button. The following window will appear:

Setup Live View

System Video Audio Network Serial Event Preset Record **User** Camera

Add User

ID	Door
Password	••••
Privilege Level	Manager

Enter User ID and password (Up to 15 characters) and select **Privilege Level**

4- Remote Configuration

- **Delete User**

Select the User to be deleted and press **Delete** button.

- **Change Password**

Press **Modify Password** button. The following window will appear:

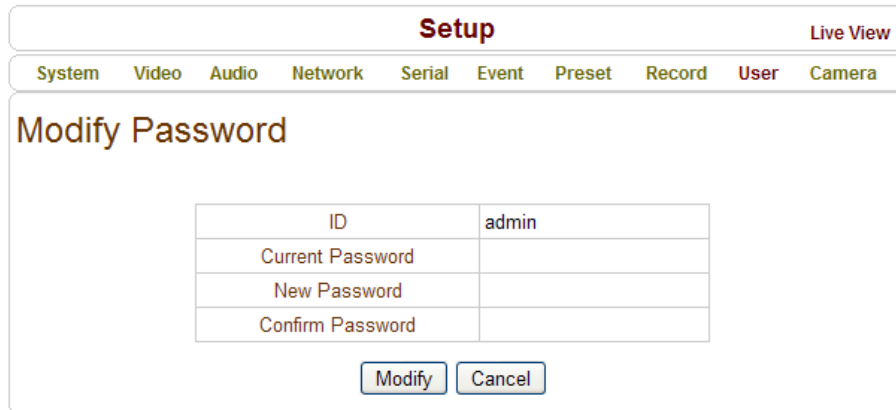

The screenshot shows a web interface titled "Setup" with a "Live View" button in the top right corner. Below the title bar is a navigation menu with tabs for System, Video, Audio, Network, Serial, Event, Preset, Record, User, and Camera. The "User" tab is selected. The main content area is titled "Modify Password" and contains a form with the following fields:

ID	admin
Current Password	
New Password	
Confirm Password	

At the bottom of the form are two buttons: "Modify" and "Cancel".

Enter the current password and then set a new password.

- **Modify Privilege Level**

Press **Modify Privilege** button to change User level. It is not allowed to change the privilege level of admin user.

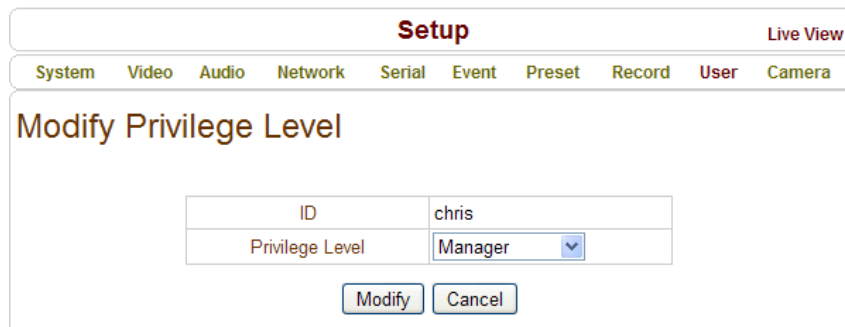

The screenshot shows a web interface titled "Setup" with a "Live View" button in the top right corner. Below the title bar is a navigation menu with tabs for System, Video, Audio, Network, Serial, Event, Preset, Record, User, and Camera. The "User" tab is selected. The main content area is titled "Modify Privilege Level" and contains a form with the following fields:

ID	chris
Privilege Level	Manager

At the bottom of the form are two buttons: "Modify" and "Cancel".

Login Policy

- **Authentication Type**

HTTP authentication based on RFC 2617 (HTTP Authentication: Basic and Digest Access Authentication) is supported.

- **Skip Login** provides for convenient access to the server when authentication is not required. When Skip Login is set to **Enable**, the login step is skipped. The privilege level after login in is determined by the setting of **Privilege Level After Login Skipped**.

5-Decoder Configuration

Decoder Configuration is slightly different from Encoder Configuration. Different configurations for the encoder will be explained in Decoder Configuration.

5.1 System Configuration

Setup Live View

SystemVideoAudioNetworkSerialEventPresetDisplayUser

System

General

System Mode Decoder ▼

System ID

Language ▼

Firmware

Version

Board ID

Upgrade

Config Backup&Restore

Backup

Restore

Time

Start Time

Current Time

Time Format ▼

Time Zone ▼

Automatically synchronize with NTP server

NTP Server Name

Reboot

5- Decoder Configuration

5.2 Video Configuration



Output Format

Regardless of Input Resolution on Encoder or IP Camera, Decoder System of Video Server can display Video Format.

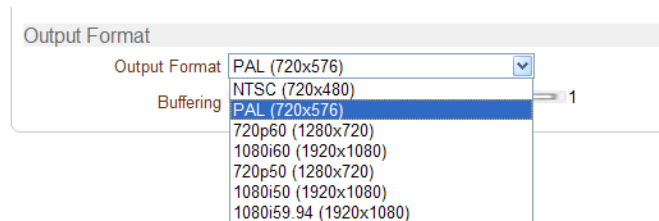

- **Buffering**

You can store maximum 30 decoded frames temporarily by using buffering before displaying the frames. Displaying stored frames is smoother than displaying in real time. However, displaying stored frames causes delay because of process of buffering.

5- Decoder Configuration

5.3 Network Configuration

Network page of Decoder has a section for specifying the remote system to connect and the other functions are same as Network Configuration of Encoder.

The screenshot shows the 'Setup' page for a Decoder, specifically the 'Network' configuration section. The interface includes tabs for System, Video, Audio, Network, Serial, Event, Preset, Display, and User. The 'Network' tab is active, and the 'Remote' section is highlighted with a red box. The 'Remote' section contains the following fields:

- Remote Type: Normal
- Media Protocol: TCP
- Remote Address: 192.168.26.102
- Port: 2222
- Remote Channel: Channel 1
- Use Streaming Server: Off
- SS IP Address: 0.0.0.0
- SS Port: 2222
- SS ID: (empty)
- SS Password: (empty)

Other sections visible in the screenshot include:

- Local:** IP Mode (Fixed IP), Local IP (192.168.26.33), Local Gateway (192.168.10.1), Local Subnet (255.255.0.0)
- DNS:** Obtain DNS server address automatically (unchecked), Use the following DNS server addresses (checked), Primary DNS Server (0.0.0.0), Secondary DNS Server (0.0.0.0)
- Port:** Base Port (2222), HTTP Port (80), HTTPS Port (443), RTSP Port (554)
- Discovery:** UPNP (Off), Zeroconf (Off), WS Discovery (Off)
- Authentication:** RTSP Authentication (Off), HTTPAPI Authentication (Off)
- RTP Session:** Use RTP Session (Off), Destination IP (0.0.0.0), Destination Port (0), User Name (empty), File Name (ch0.sdp)
- SNMP:** SNMP Listen port (161), SNMP Trap Destination IP (0.0.0.0), SNMP Trap Destination Port (162)
- DDNS:** DDNS Server (None), Check IP Disable (unchecked)
- Address Information:** Current IP (192.168.26.33), Current Domain (Not Registered), MAC Address (00:1C:63:A6:04:2E), Connecting (1: 192.168.10.71, 2: 192.168.26.102)

5- Decoder Configuration

- **Remote Type**

- Normal: Connection for Marshall Encoder and Decoder.
- RTSP/RTP: Decoder system can make connection though RTSP protocol and get the stream via RTP. It is also possible to make connection with other vendor's H.264 IP camera supporting standard RTSP/RTP and standard H.264 algorithm.
- To make RTSP Connection, set *Remote Type* to "RTSP", enter the RTSP URL of remote system to *Remote Address*, and RTSP access port number to *Remote Port*. Currently supports video only.

- **Media Protocol**

Select protocol used for transmission of audio and video data between remote system and decoder. The decoder system or VMS can choose media protocol among TCP, UDP and Multicast.

- **Remote Address**

Address of the remote system to connect.

- **Port**

Port of the remote system to connect.

- **Remote Channel**

The channel can be selectable when the remote system has more than multiple video channels.

- **Use Streaming Server**

- Decoder system has the settings to connect to Encoder or IP Camera via the Streaming Server. To connect to Encoder or IP Camera via Streaming Server, **Use Streaming Server** of **Remote** group in **Network** page should be set to **ON** and information of the **Streaming Server (SS)** needs to be configured appropriately.
- **SS IP Address:** IP address of Streaming Server.
- **SS Port:** Enter Port number that is set when registering Streaming Server.
- **SS ID:** Enter Streaming Server ID.
- **SS Password:** Enter Streaming Server Password.

The screenshot shows a configuration window titled "Remote" with the following fields and values:

- Remote Type: Normal (dropdown)
- Media Protocol: TCP (dropdown)
- Remote Address: 192.168.10.243 (text input)
- Port: 2222 (text input)
- Remote Channel: Channel 1 (dropdown)
- Use Streaming Server: Off (radio button selected)
- SS IP Address: 0.0.0.0 (text input)
- SS Port: 2222 (text input)
- SS ID: admin (text input)
- SS Password: masked with dots (password input)

5- Decoder Configuration

5.4 Event Configuration

Setup Live View

System
Video
Audio
Network
Serial
Event
Preset
Display
User

Event
Apply

Local

Sensor1 Beep Alarm1 Alarm2

Sensor2 Beep Alarm1 Alarm2

Remote

Sensor1 Beep Alarm1 Alarm2

Sensor2 Beep Alarm1 Alarm2

Sensor3 Beep Alarm1 Alarm2

Sensor4 Beep Alarm1 Alarm2

On Video Loss Beep Alarm1 Alarm2

On Motion Beep Alarm1 Alarm2

On Disconnect

On Disconnect Beep Alarm1 Alarm2

Duration

Beep

Alarm1

Alarm2

The Event Configuration configures the actions for each event type. **Local** section configures the actions for events from local (self=decoder) system, and configuration activates local devices and **Remote** sections configures the actions for events from Remote (Encoder or IP Camera) System. The following table lists the possible actions for events:

Action	Description
Beep	Outputs beep sound using the buzzer in the system
Alarm1/Alarm2	Triggers alarm (relay) port.
Email	Sends Email to the specified address. AVI file can be attached
FTP	Upload AVI file to a specified FTP server
Preset	Moves the PTZ to associated preset position

5- Decoder Configuration

- **Sensor1 / Sensor2**

Configure the actions when the sensor 1 or 2 is activated. Multiple actions can be set for a single event.

- **On Video Loss**

Configure the actions when video input signal is lost. Multiple actions can be set for a single event.

- **On Motion**

Configure the actions when motion is detected. Multiple actions can be set for a single event.

- **On Disconnect**

Configure the actions when the link (connection) with peer system is disconnected. Multiple actions can be set for a single event.

- **Alarm and Beep Activation Duration**

Set the duration of alarm or beep activation in case of an event. If it is set to continuous, it will be in active state until an operator reset it manually.

5- Decoder Configuration

5.5 Display Configuration

- **Disconnection**

Decoder system's output mode on disconnected state can be configured.

- **Freeze:** Video image of the last frame is shown when there is disconnection.
- **Black Screen:** Black Screen is shown when there is disconnection.

- **LED**

Select from Video, Audio and Serial to be indicated by Data LED. When there is the selected Data (Video or Audio or Serial) Communication between the Encoder and the Decoder, Data LED will indicate the status.

The screenshot shows a web-based configuration interface titled "Setup" with a "Live View" link in the top right. Below the title is a navigation menu with tabs for "System", "Video", "Audio", "Network", "Serial", "Event", "Preset", "Display", and "User". The "Display" tab is currently selected. The main content area is titled "Display" and includes an "Apply" button. Under the "Disconnect" section, there are two radio button options: "Freeze" (which is selected) and "Black Screen". Below this is an "LED" section with a dropdown menu currently set to "Video".

6- VS Manager

VS Manager is a program used for basic configuration, diagnostics and firmware upgrade of video servers or IP cameras. **VS Manager** provides the following features:

- Finding Servers on the LAN and assigning IP Addresses.
- Monitoring Server Status: Encoding/Decoding, Serial, Sensor, etc.
- Diagnostic Function: PING, Network Bandwidth Measurement, Video/Audio Output, Port Check, Serial Port Check.
- Firmware Upgrade.

7-Appendix

Appendix A: Sensor and Alarm Port

Sensor Port

- **Terminal Type**
 - Voltage Rating: 150VAC
 - Current Rating : 2A
 - Color : Red
- **Sensor Signal Input Type**
 - NO Contact Signals
- **Connection to External Device**

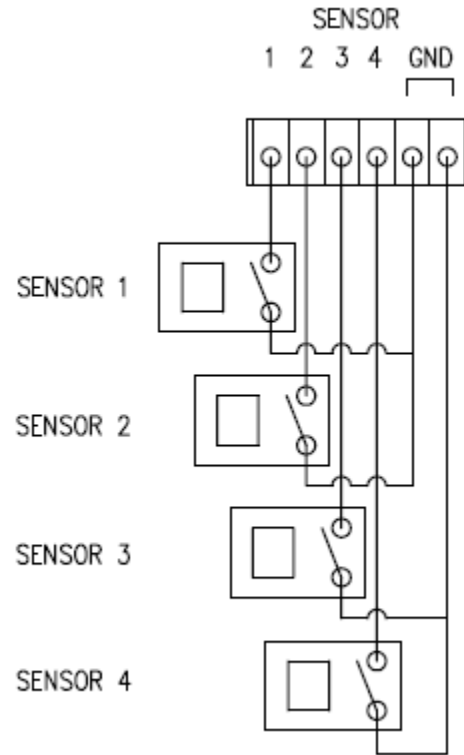

Alarm Port

- **Terminal Type**
 - Voltage Rating: 150VAC
 - Current Rating : 2A
- **Relay Type**
 - Contact Rating : 1A 30VDC
 - Switching Power : Max 30W 62.5VA
 - Switching Voltage : Max 60VDC
- **Alarm Signal Output Type**
 - NO/NC Contact Signals
- **Connection to External Device**

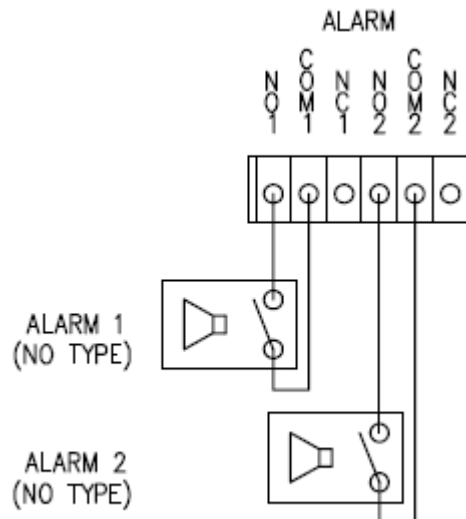

7- Appendix

Appendix B: Serial Port

RS-232 Port

- **Terminal Type**
- 3 PIN
- Pin Arrangement

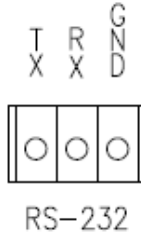

Pin Description:

Pin NO	Pin Name	Description
1	TX	RS232 TX(Transmit)
2	RX	RS232 RX(Receive)
3	GND	Ground

RS-422/485 Port

- **Port Type**
- 4 PIN
- Pin Diagram

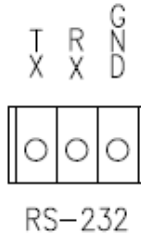

Pin Description:

Pin No.	Pin Name	Description
1	RX-	RS422 RX-
2	RX+	RS422 RX+
3	TX-	RS422 TX- or RS485 TRX- It is selectable by S/W Setup
4	TX+	RS422 TX+ or RS485 TRX+ It is selectable by S/W Setup

Marshall Electronics, Inc.
1910 East Maple Ave. El Segundo, CA 90245
Tel: (800) 800-6608 / (310) 333-0606 • Fax (310) 333-0688
www.LCDRacks.com • sales@lcdracks.com