

# Marshall Electronics

Model No. V-MD185

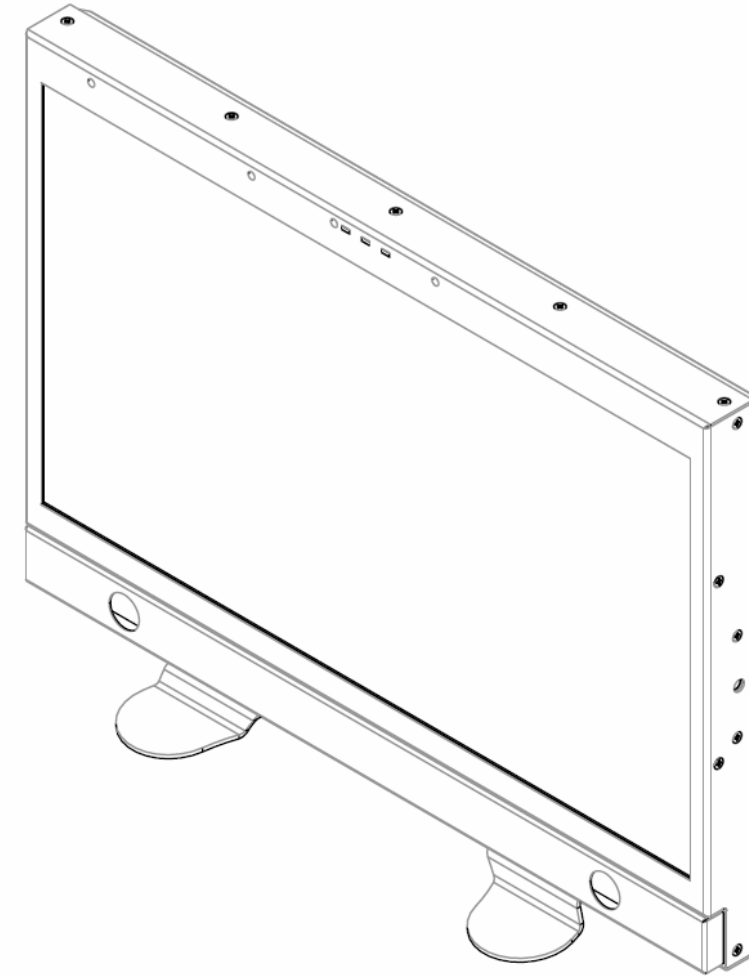

## Operating Instructions

Edition 1 Revision 10P

# Maintenance

- **Screen Cleaning**

Periodically clean the screen surface using ammonia-free cleaning wipes (Marshall Part No. V-HWP-K). A clean micro-fiber cloth can also be used using only non-abrasive and ammonia-free cleaning agents. Do not use paper towels. Paper towel fibers are coarse and may scratch the surface of the polycarbonate faceplate or leave streaks on the surface. Antistatic and fingerprint resistant cleaning agents are recommended. Do not apply excessive pressure to the screen to avoid damaging the LCD.

- **Faceplate Dusting**

Dust the unit with a soft, damp cloth or chamois. Dry or abrasive cloths may cause electrostatic charge on the surface, attracting dust particles. Neutralize static electricity effects by using the recommended cleaning and polishing practice.

# Warranty

Marshall Electronics warrants to the first consumer that this V-MD185 LCD monitor will, under normal use, be free from defects in workmanship and materials, when received in its original container, for a period of one year from the purchase date. This warranty is extended to the first consumer only, and proof of purchase is necessary to honor the warranty. If there is no proof of purchase provided with a warranty claim, Marshall Electronics reserves the right not to honor the warranty set forth above. Therefore, labor and parts may be charged to the consumer. This warranty does not apply to the product exterior or cosmetics. Misuse, abnormal handling, alterations or modifications in design or construction void this warranty. It is considered normal for a minimal amount of pixels, not to exceed three, to fail on the periphery of the display active viewing area. Marshall Electronics reserves the option to refuse service for display pixel failure if deemed unobtrusive to effective use of the monitor by our technicians. No sales personnel of the seller or any other person is authorized to make any warranties other than those described above, or to extend the duration of any warranties on behalf of Marshall Electronics, beyond the time period described above. Due to constant effort to improve products and product features, specifications may change without notice.

Marshall Electronics, Inc.  
1910 East Maple Ave.  
El Segundo, CA 90245  
Tel: (800) 800-6608 / (310) 333-0606 • Fax: 310-333-0688  
[www.LCDRacks.com](http://www.LCDRacks.com) • [sales@lcdracks.com](mailto:sales@lcdracks.com)

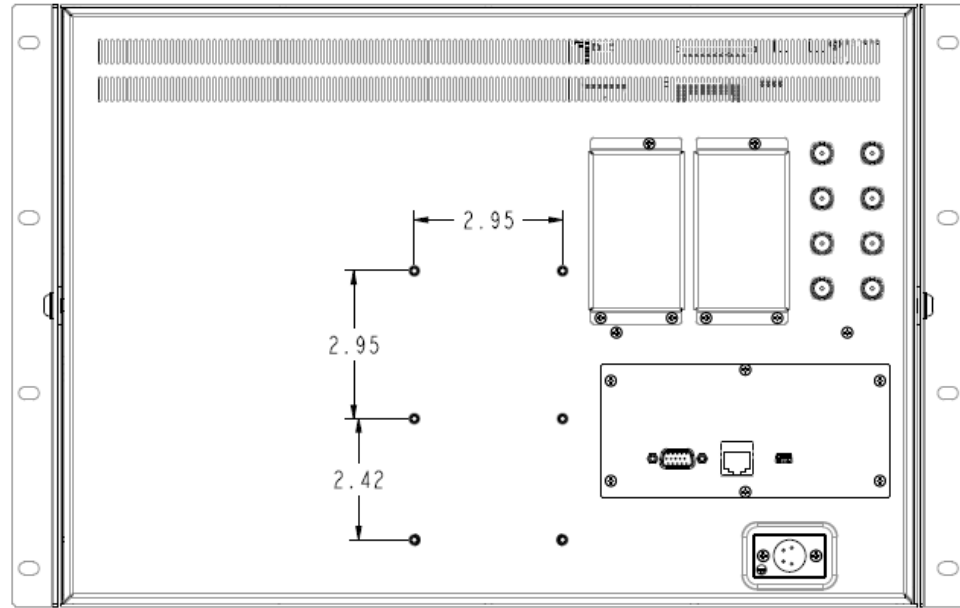

# Table of Contents

Installation and Initial Setup .....	5
Top and Front Panel Features .....	7
Rear Panel Features.....	8
Compatible Input Formats.....	9
Input Module Installation.....	10
MAIN MENU AND NAVIGATION.....	11
VIDEO CONFIGURATION SUBMENU.....	11
MARKER CONFIGURATION SUBMENU .....	13
FILTER CONFIGURATION SUBMENU.....	16
SYSTEM CONFIGURATION SUBMENU .....	18
FUNCTION PRESETS SUBMENU .....	19
IMD & TALLY CONFIGURATION .....	20
SYSTEM INFORMATION SUBMENU .....	21
NETWORK CONFIGURATION SUBMENU .....	21
Network Control Page.....	23
Power Tab .....	23
Menu Tab .....	23
Function Presets.....	25
IMD / Tally Config.....	25
Display Tab .....	26
Keypad Tab.....	26
Tally Tab .....	26
Network Tab.....	27
Network Configuration.....	27
Navigator .....	28
Info Tab .....	28
Global .....	29
Specifications.....	30
Dimensions.....	31
Maintenance.....	35
Warranty .....	35

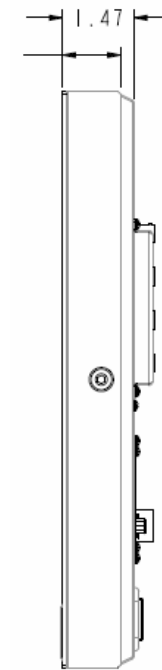
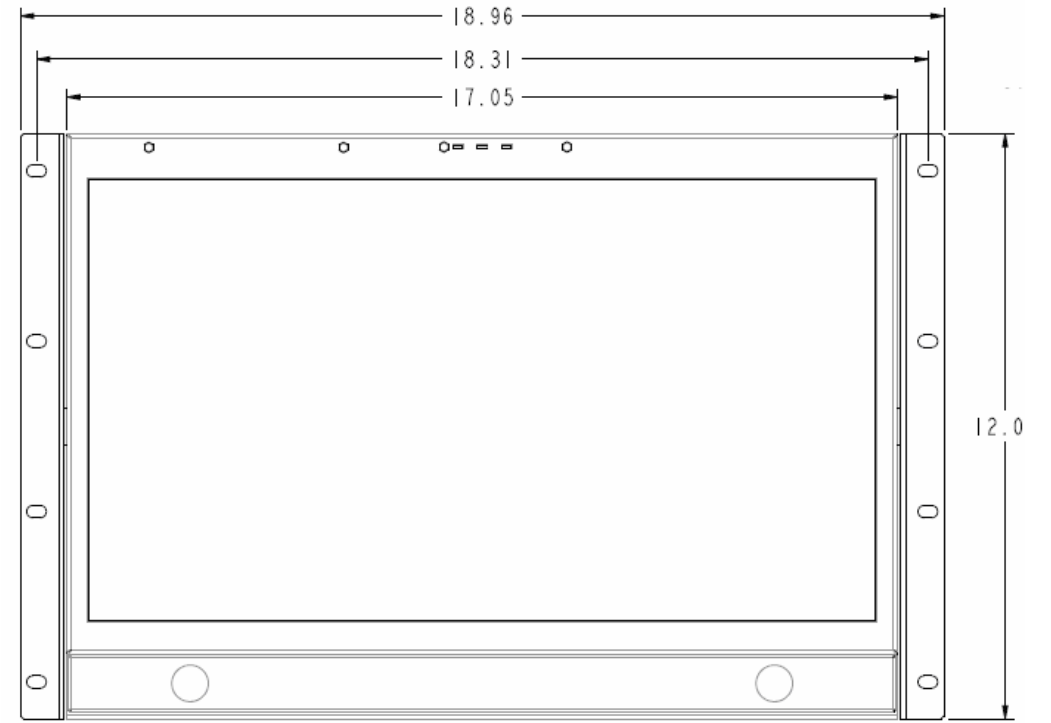
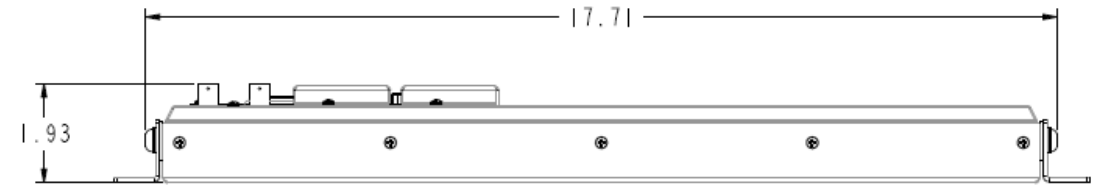



# Installation and Initial Setup

## ■ Unpacking

Carefully unpack the V-MD185 monitor and verify that the following items are included:

- V-MD185 Monitor
- V-PS12-5V-XLR Power Supply
- Operating Instructions

Inspect the unit for any physical damage that may have occurred during shipping. Should there be any damage, immediately contact Marshall Electronics at (800) 800-6608. If you are not located within the continental United States, call +1 (310) 333-0606.

## ■ Installation

The V-MD185 can be mounted in any standard EIA 19" equipment rack. The attached rack ears can be angled to provide the user control over the viewing angle. Adequate ventilation is required when installed to prevent possible damage to the monitor's internal components. Please see the [Dimensions](#) section for more information.

## ■ Connections, Power-On and Initial Setup

Plug the power supply into an AC power source (100-240 V @ 50/60 Hz). Attach the Power connector to the back of the monitor. Connect the required cables for video signal input and output. (Power must be applied to the V-MD185 for the active loop-through output to be activated.) The monitor defaults to 'ON' when power is supplied. Video will automatically be detected and displayed on the screen.

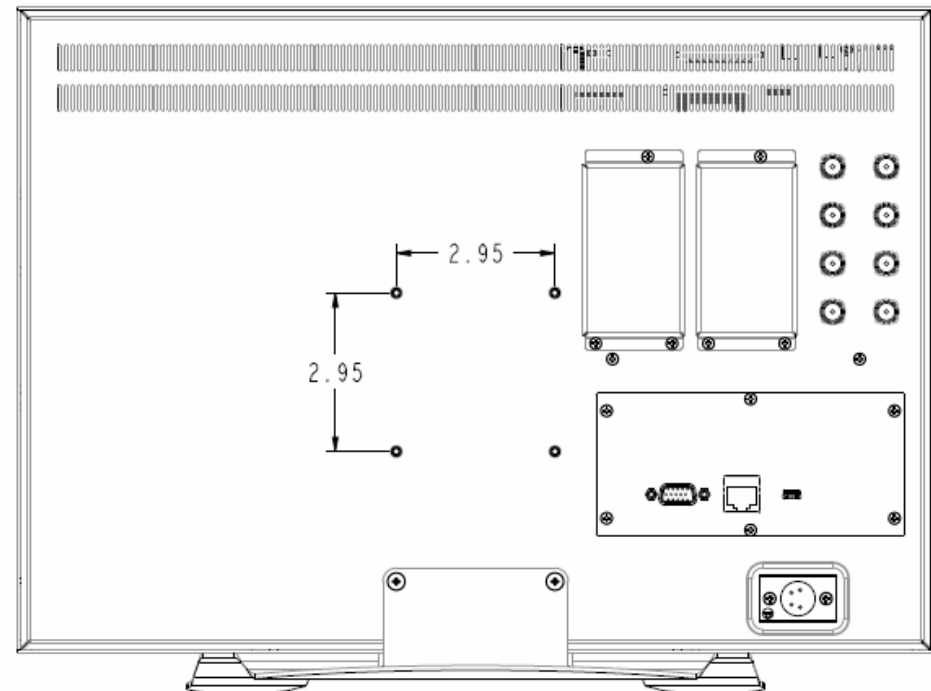

# Dimensions

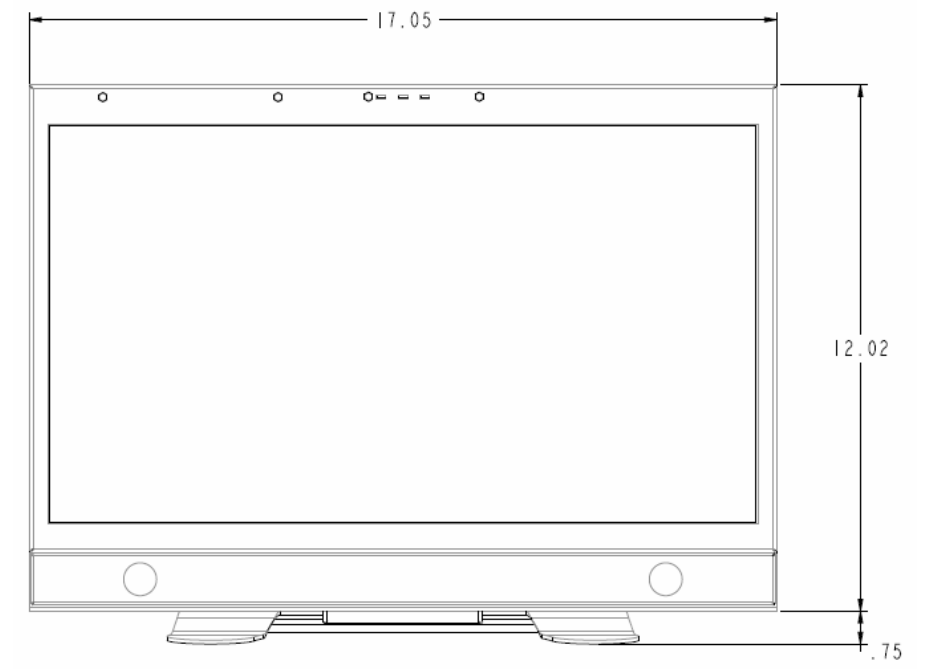
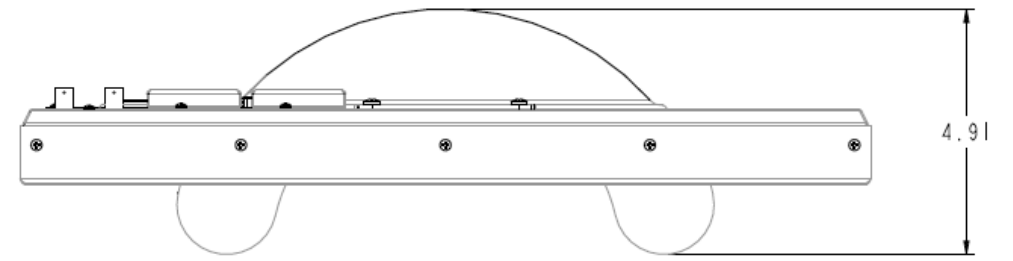

# Specifications

- PANEL**

Screen Size	18.5" Diagonal
Display Area (h x v)	409.8 x 230.4 mm
Pixels	1366 x RGB x 768
Viewing Angle (h x v)	178° x 178°
Brightness	300 cd/m2
Contrast Ratio	1000:1
Pixel Pitch (h x v)	0.100 x 0.300 mm

- CONNECTORS**

- Video Input**

- |                   |                       |
|-------------------|-----------------------|
| Video (Composite) | 1 x BNC Female (75 Ω) |
| YPbPr (Component) | 3 x BNC Female (75 Ω) |

- Video Output (Active Loop-Through)**

- |                   |                       |
|-------------------|-----------------------|
| Video (Composite) | 1 x BNC Female (75 Ω) |
| YPbPr (Component) | 3 x BNC Female (75 Ω) |

- S1 / S2 (Module Slot)**

- For Marshall I/O Modules Only  
Cold-Swap – remove power from unit before  
Inserting or removing Modules.

- Power Input**

- 4-Pin Female XLR

- Tally Hardware Interface**

- HD-15 Female

- PROGRAM – Programming Port\***

- Factory / Upgrade Use Only

- Ethernet Control Interface**

- RJ-45 6p6c Female Connector

- TALLY Hardware Interface (HD-15)**

Activation requires contact closure of pin to ground on the HD-15 connector:



- ELECTRICAL**

- |                     |                     |
|---------------------|---------------------|
| Power Consumption   | 3.5A @ 12VDC (42 W) |
| Voltage Requirement | 12 VDC              |

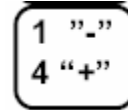

- MECHANICAL**

- |                          |                               |
|--------------------------|-------------------------------|
| Weight (with rack ears): | 8.25 lbs                      |
| Operating Temperature    | 32°F to 104°F (0°C to 40°C)   |
| Storage Temperature      | -4°F to 120°F (-20°C to 50°C) |

See [Dimensions](#) section for detailed measurement specifications.

# Top and Front Panel Features

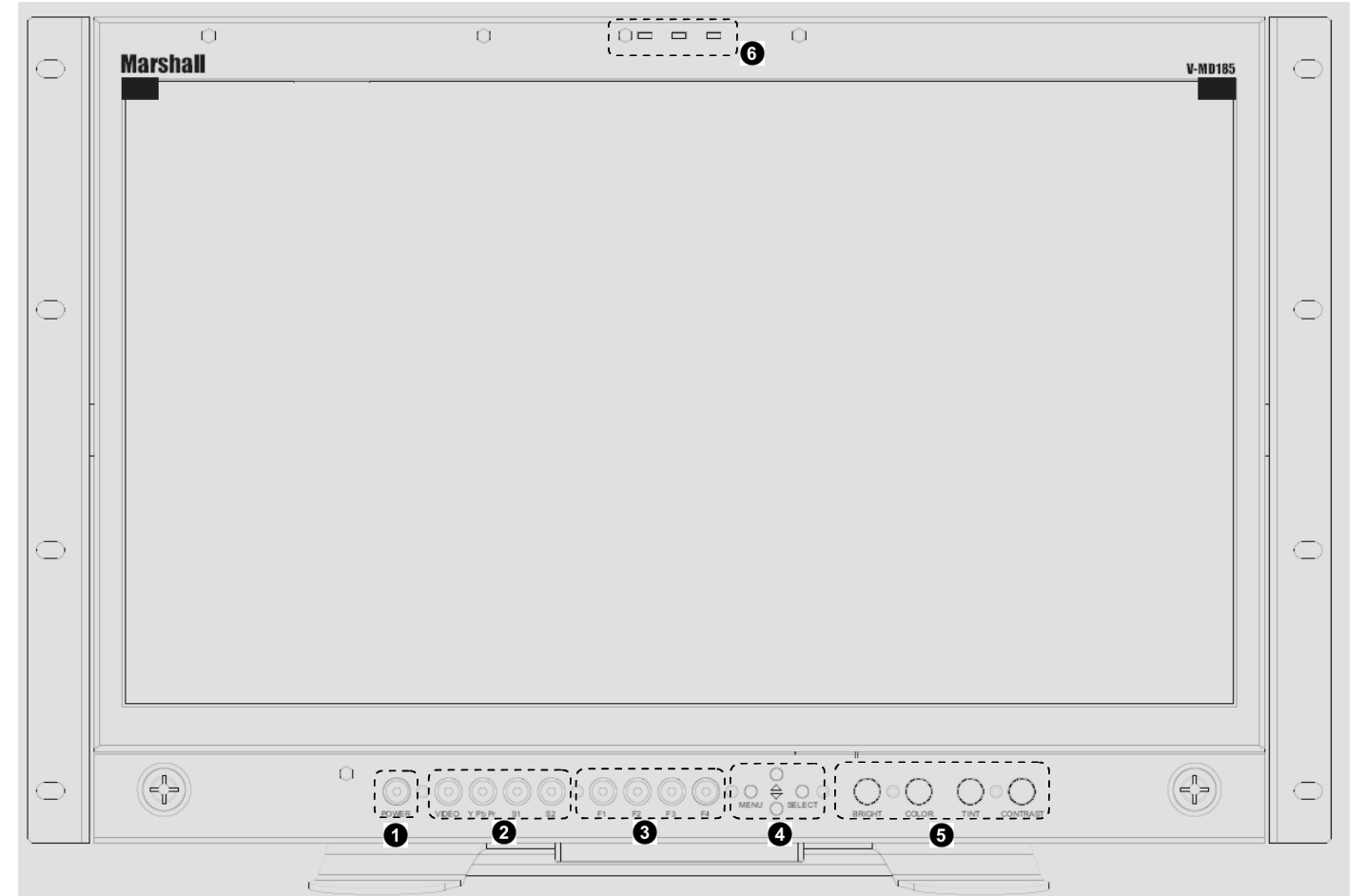

**1 Power Button**

Use the power button to toggle between ON and STANDBY modes. In both the STANDBY and the ON state, the LED on the button will illuminate bright green. This indicates that MAIN power is applied to the unit.

**2 Input Select Buttons**

Use the VIDEO, YPbPr, S1 and S2 buttons to select the corresponding input signal. Video standards (NTSC/PAL, etc.) are automatically detected. S1 and S2 buttons select inputs connect to the Optional Input Module slots.

**3 User-Definable Function Buttons**

Four user-definable function buttons can be used for direct access to various settings. Functions are assigned using the on-screen menu.

**4 Menu Navigation Buttons**

Use the Menu, ▲, ▼, and Select buttons to display and navigate the on-screen menu ([See Main Menu and Navigation](#)).

**5 Image Adjustment Knobs**

Use the image adjustment knobs to adjust tint, color brightness, color-saturation and contrast of the image. The status of each image adjustment parameter is shown on the bottom left of the screen, with values ranging from 0 to 100. Default value is 50.

**6 LED Tally**

Three LED tally lights (yellow, red, green) are available above the screen.

# Rear Panel Features

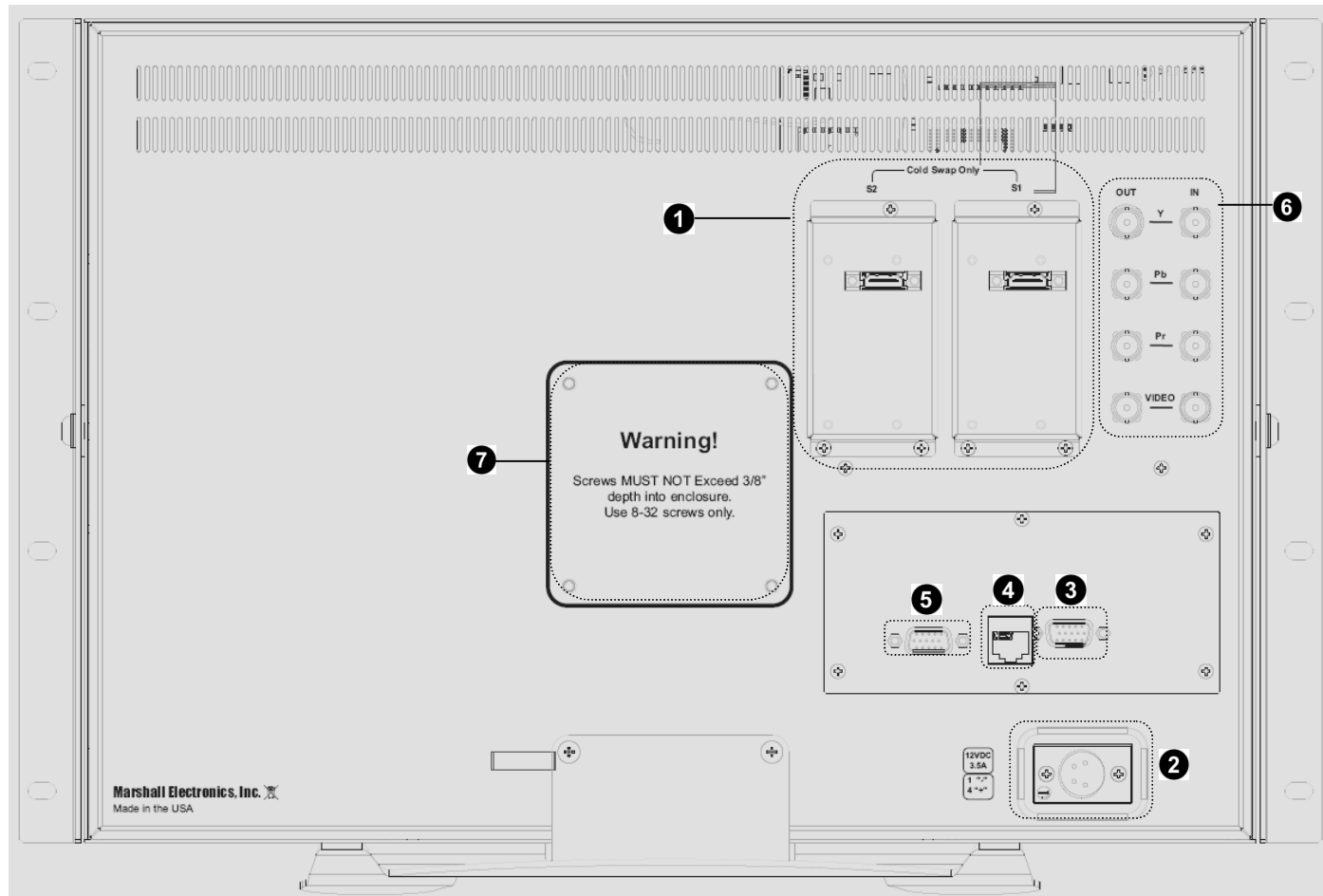

## 1 Module Slots 1/ 2

The V-MD monitor comes with Module Slots for Marshall Electronics' line of future proof Input Modules. Please contact Marshall Electronics for a list of compatible Input Modules. See the [Input Module Installation](#) instructions for details on Module installation.

## 2 Power Input

Connect 12VDC to the power input connector. Power should only be supplied from the included power supply.

IMPORTANT: If using a power source other than the included power supply, damage may result. Please use the pin out diagram in the [Specifications](#) section.

## 3 Tally Input Connector

The LED tally can be activated via the [HD-15 connector](#) by connecting the corresponding pin to ground. A variety of external devices can be used to perform the contact closure. No additional power should be supplied to the HD-15 port.

## 4 Network Port

The Network Port is used to access the Network Control Page for the V-MD185 monitor. Use a regular RJ45 Ethernet cable to connect the V-MD monitor to your network. Please see the [Network Configuration Submenu](#) section of this manual for further connection details.

## 5 PROG Port

The PROG port is a Service / Upgrade port only. Please contact Marshall Electronics for more information.

## 6 Video and YPbPr Inputs / Outputs

The V-MD185 has Video (CVBS) and YPbPr inputs and active loop-through outputs. See the [Compatible Input Formats](#) for a list of accepted formats.

## 7 VESA 75mm Hole Pattern

VESA-standard 75 mm hole pattern is provided to accommodate a variety of custom mounting options.

# Global

Use the Global tab to control multiple Marshall Electronics MD monitors simultaneously. Only the POWER, MENU and DISPLAY tabs may be used on the GLOBAL scale. All other options must be used on an individual monitor basis.

To control monitors globally:

- 1) Click on the GLOBAL CONTROL tab on the bottom of the web page. This will display the GLOBAL CONTROL menu.
- 2) Press the SCAN NETWORK button at the bottom of the GLOBAL CONTROL menu. This will scan your network for any other MD series monitors and list them under SELECT MONITORS TO CONTROL list.
- 3) Click on all monitors that you wish to control with the GLOBAL CONTROL settings.
- 4) Click on the POWER, MENU or DISPLAY buttons that you wish to control.

## Scan Network

Use the Scan Network button to scan for any other Marshall Electronics MD monitor connected on your network. The results will show up in the **SELECT MONITORS TO CONTROL** box.

## SELECT MONITORS TO CONTROL box

This box will list any MD Series monitors found on your network. The box will list the following items about each monitor: Host Name, IP Address, Model. The IDENTIFY section allows you to identify a particular monitor by toggling all 3 Tally LEDs at once. Use this to determine which physical monitor you will be controlling.

## Monitor Count

Use this count to quickly identify the number of Marshall Electronics MD monitors on your network.



## Navigator

The Network Control page's Navigator allows you to scan your network for any other Marshall Electronics Web Enabled MD monitors. From the navigator, you can find and sort all monitors by their Host Name, IP Address or Model number. You can also access each monitor's Network Control page.

Press the Scan Network button once to scan your network for other MD monitors. The navigator will not detect any monitors added to the network if the scan was performed prior to their installation.

The information field at the bottom will indicate the Host Name, IP Address and model number of the origin of the Navigator pop up page. It will also give a count of how many monitors have been found on the network.

## Info Tab

### ■ System

This shows the System firmware version of your monitor.

### ■ Power Module

This shows the Power Module firmware version of your monitor.

### ■ Keypad

This shows the Keypad firmware version if your monitor has a Keypad separate from the main system board.

### ■ Slot

This field determines the type of module present on the system as well as its firmware version. If there is no module installed, the text will read "No Module v0.00."

# Compatible Input Formats

The following video standards are supported by the V-MD185:

## Video Input

NTSC, PAL

## YPbPr Input

480i, 576i/50

480p, 576p/50

720p/25, 29.97, 30, 50, 59.94, 60

1080p/23.98, 23.98sF, 24, 24sF

1080i/50, 59.94, 60

## Input Modules (Type-A modules)

### MD-3GSDI and MD-TC – 3G/HD/SDI Input Module with Loop-Through

525i, 625i/50

720p/25, 29.97, 30, 50, 59.94, 60

1080p/23.98, 23.98sF, 24, 24sF, 25, 29, 30

1080i/50, 59.94, 60

#### 3G – Level A and Level B

**YCbCr, YCbCr+A, RGB, RGB+A**

1080p/ 60, 59.94, 50

1080p/ 30, 29.97, 25, 24, 23.98, 30sF, 29.97sF, 25sF, 24sF, 23.98sF

1080i/ 60, 59.94, 50

### MD-HDSIx2 – Two-channel HD-SDI Input Module with switched output

525i, 625i/50

720p/25, 29.97, 30, 50, 59.94, 60

1080p/23.98, 23.98sF, 24, 24sF, 25, 29, 30

1080i/50, 59.94, 60

### MD-HDMIx2 – Two-channel HDMI Input Module

480p/59.94, 576p/50

720p/25, 29.97, 30, 50, 59.94, 60

1080p/23.98, 23.98sF, 24, 24sF, 25, 29, 30

1080i/50, 59.94, 60

### MD-DVII – DVI-I Input Module

640 x 480/ 60, 75, 85

800 x 600/ 60, 75, 85

1024 x 768/ 60, 75, 85

1280 x 1024/ 60, 75

1600 x 1200/ 60 (CVT Timing)

1920 x 1200/ 60 (CVT Timing)

# Input Module Installation

## 1. Remove Power From Unit

- Modules are cold-swappable only. Damage will occur if modules are inserted or removed while unit is powered.

## 2. Remove Blank Module Cover

- Using Philips screwdriver, remove the 4-40x1/8" screws. There are a total of three screws, save them for later use.
- Remove blank cover

## 3. Insert Optional Module

- Decide which slot you intend to install module (Slot 1 or Slot 2)
- Carefully align the module with the chosen slot. The raised rails will fit inside the module
- Align the Module so that the three (3) mounting holes all line up with the threaded holes of the slot.
- The connectors on both the module and the main-board slot should now be in alignment.
- Carefully PRESS the module into the slot. Module will seat flush with the rear of the unit.
- Replace the three (3) screws removed in Step 2.

\*NOTE\* Use ONLY 4-40x1/8" screws provided. Any screw longer than 1/8" will damage the main unit.

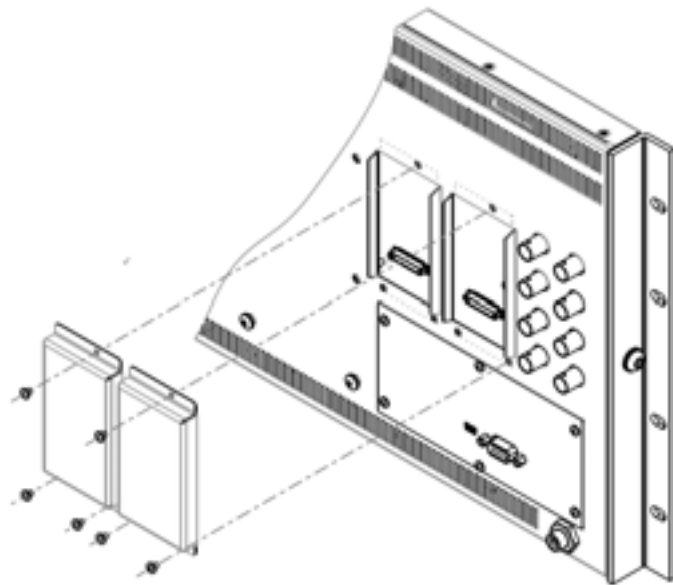

The radio buttons allow for customization of tally lights to be used by the monitor.

## Network Tab

### Network Configuration

#### ■ Remote Enable

Select whether you would like to be able to access a particular monitor's web page or web functions from another monitor on the same network or only through the current monitor's web page.

#### ■ Configuration Mode

Use this drop down menu to select between the different IP configuration modes available for the monitor.

#### ■ IP Address

If you have selected the Manual configuration mode for the IP configuration mode, you will be able to enter an IP address manually in this field. If you have selected DHCP, the box will have an IP address already entered. This cannot be modified when in DHCP mode.

#### ■ Subnet Mask

If you have selected the Manual configuration mode for the IP configuration mode, you will be able to enter Subnet Mask address manually in this field. If you have selected DHCP, the box will have Subnet Mask already entered. This cannot be modified when in DHCP mode.

#### ■ Default Gateway

If you have selected the Manual configuration mode for the IP configuration mode, you will be able to enter Default Gateway address manually in this field. If you have selected DHCP, the box will have Default Gateway already entered. This cannot be modified when in DHCP mode.

#### ■ Host Name

Use this field to enter a Host Name for the monitor. You may choose up to 15 alphanumeric characters for the Host Name.

#### ■ Web Authentication

Fill in the Web Authentication box to protect the monitor from being accessed by a user without a User Name and Password. Filling this box in will enable the Username and Password fields below.

##### ■ Username

Enter a 15 alphanumeric character string Username in this field. This will only work if the Web Authentication option has been turned ON.

##### ■ Enter Password / Re-enter Password

Enter a 15 alphanumeric character string Password in this field. You will need to Re-enter the password in the box below the Enter Password box for additional security.

#### ■ MAC Address

This is the unique MAC address for this monitor. This cannot be changed.

To save all changes, press the Apply Changes button. You may also cancel out of the changes you have made by pressing the Cancel button.

### ■ Tally Source

Use this row to determine the current source for the LED tally lights on each individual panel. Use the drop down menu to select between the different tally sources.

### ■ LED Tally

Use this to turn the physical LED Tally lights ON or OFF.

### ■ On-Screen Tally

Use this to turn the On-Screen Tally lights ON or OFF.

### ■ Text Tally

Use this to turn the Text Tally function ON or OFF.

## Display Tab

### Image Adjust

### ■ BRIGHTNESS, COLOR, CONTRAST

Use this section to adjust the Brightness, Color and Contrast of each individual panel. To enter a value manually, type in a number from 0-100 in the dialogue box and press Set. The value selected on this page will show up on the monitor screen in real time.

### RGB Gain / Bias

### ■ RGB Gain and Bias

Use this section to adjust the Gain and Bias for the Red, Green and Blue components of the video signal. To enter a value manually, type in a number from 0-100 in the dialogue box and press Set.

### Backlight

### ■ Backlight

Use this section to adjust the Backlight value for the monitor. To enter a value manually, type in a number from 0-100 in the dialogue box and press Set.

## Keypad Tab

### Keypad

Use the keypad portion of the Network Control page to access all aspects of the physical keypad from the Network Control page.

## Tally Tab

### Tally

Use the Tally page, in conjunction with the LAN100 tally source, to control the LED and soft tally on the monitor.

# MAIN MENU AND NAVIGATION

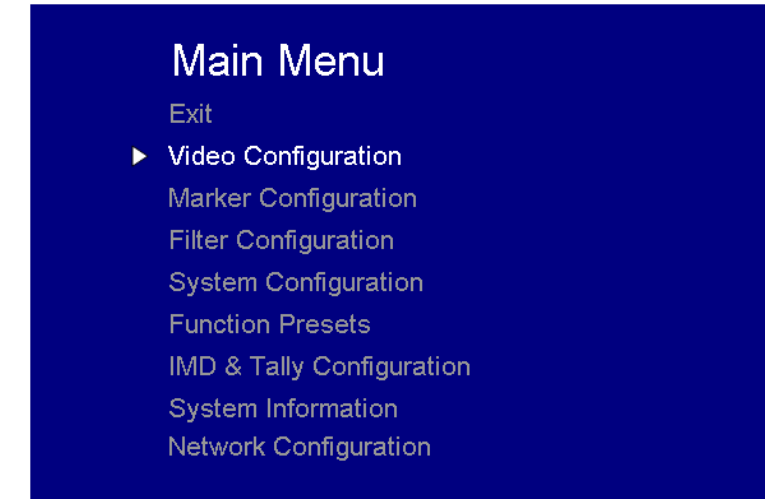

Access the main menu by pushing and holding the **MENU** button on the front panel of the monitor.

- Step through menu items using the **▲** and **▼** buttons.
- Choose a submenu or select a menu item by pressing **SELECT**.
- Return to the previous menu by pressing **MENU**.
- Exit the main menu by pressing **MENU**. The menu will automatically time out after 15 seconds.

## VIDEO CONFIGURATION SUBMENU

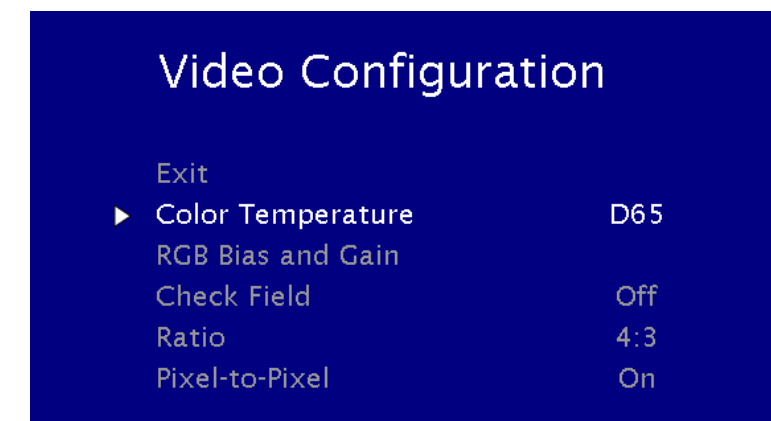

### ■ Color Temperature

Use this setting to choose one of three color temperature presets:

- D55 (5500K)
- D65 (6500K)
- 9300K

- USER (Adjustable Color Bias and Gain)
- Linear (No processing is applied to the panel)

Use this setting to enable monochrome mode. Only the luminance of the image will be displayed as a grayscale picture.

### ■ RGB Bias and Gain

Select this submenu to fine-tune the monitor's color balance (R, G, B). This should only be done by someone experienced with video engineering, as this will alter the overall color shading of the screen. The purpose is to allow color matching to other types of monitors and/or displays. Note: The Color Temperature preset will automatically switch to USER when Color Bias settings are adjusted. It is normal for color bias adjustments to be very subtle.

When selecting the RGB Bias and Gain submenu, gain adjustment indicators will appear at the top of the screen, and bias adjustment indicators will appear at the bottom of the screen:

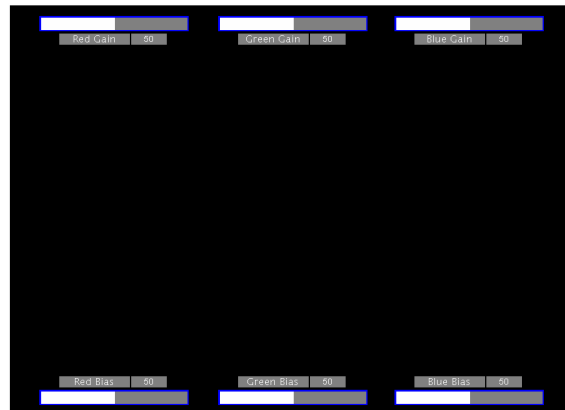

RGB Bias and Gain

Use the ▲ and ▼ buttons to select each individual bias or gain control. Press SELECT to begin adjusting the control. Use the ▲ and ▼ buttons to increase or decrease the value.

Alternately, the image adjustment buttons (Brightness, Color, Tint, Contrast) can be used to easily adjust the bias and gain settings as shown below. The buttons affect whichever row of controls (gain or bias) is currently selected.

### ■ Check Field

Use the check field modes for monitor calibration or to analyze individual color components of an image. In Monochrome mode, all color is disabled and only a grayscale image is shown. In Blue, Green, and Red check field modes, only the selected color will be shown.

Use the following procedure when calibrating the monitor to SMPTE color bars with the following procedure:

1. Allow the monitor to warm up for at least 5-10 minutes.
2. Display SMPTE split-field color bars on the monitor using an external source.
3. Enable **Monochrome mode**.
4. Locate the pluge pattern (super black, black, and gray bars) at the lower-right corner of the screen. Adjust the **Brightness** button until there is no visible difference between the super black and black bars, but the gray bar is still visible.
5. Adjust the **Contrast** button until an even grayscale appears along the top bars.

### ■ Contrast/Backlight

Use this row to select what function should be controlled by the CONTRAST buttons on the physical unit or on the Network Control Page.

### ■ Load Setup

Use this row to load any of the Setup configuration files available on the monitor.

This can be selected for each individual panel, or on the global level under the GLOBAL column. When selecting from the GLOBAL column, each individual panel will load its own individual settings. For example, if you select User 3 from the GLOBAL column, each panel will load a separate User 3 setting, not a single file.

### ■ Save Setup

Use this row to Save the current configuration on each individual panel or on the global level.

When selecting from the GLOBAL column, each individual panel will save its own individual settings. For example, if you select User 3 from the GLOBAL column, each panel will save a separate User 3 setting, not a single file.

### ■ Setup Name

Use this dialogue box to rename the User configuration files available. Choose up to 16 characters to customize the names of the User configuration files.

### ■ Power-On Setup

Use this row to select the settings to be loaded when power is applied to the monitor.

## Function Presets

### ■ Function on F Buttons

Use these rows to select the functions set to be controlled by the F buttons on the physical unit or on the Network Control page.

## IMD / Tally Config

### ■ Text Enable

Use this row to turn the monitor's IMD text ON or OFF.

### ■ Text String

Use the dialogue box in this row to enter a text string that will be displayed on the monitors. You may enter up to 16 characters in this dialogue box. To confirm your text entry, press the Set button below the dialogue box.

### ■ Text Color

Use this row to change the color of the text in the Text String field.

### ■ Text Background

Use this row to toggle between different settings for the IMD Text String's background transparency.

### ■ Text Alignment

Use this row to select the alignment of the IMD text.

### ■ Aspect Ratio

Use this row to set the current Aspect Ratio mode being used on an individual screen.

### ■ Pixel-to-Pixel

Use this row to set the current state of the Pixel-to-Pixel feature of the monitor. Pressing one of the boxes under each Screen type will either turn Pixel-to-Pixel mode OFF or ON.

## Marker Config

### ■ Marker Enable

Use this row to turn the screen markers on an individual screen ON or OFF.

### ■ Center Marker

Use this row to turn the Center Marker on an individual screen ON or OFF.

### ■ 16:9 Markers

Use this row to set one of several 16:9 markers available on the monitor.

### ■ Full Screen Markers

Use this row to set one of several Full Screen markers available on the monitor.

### ■ 4:3 Markers

Use this row to set one of several 4:3 markers available on the monitor.

### ■ Marker Background

Use this row to set the current status of the transparency settings of the screen markers on each individual panel.

## Filter Config

### ■ False Colors

Use this row to turn the False Color filter on an individual screen ON or OFF.

### ■ Mosquito Filter

Use this row to turn the Mosquito Filter on an individual screen ON or OFF.

## System Config

### ■ Input Format OSD

Use this row to set the Input Format OSD timeout length.

### ■ Curtain Color

Use this row to set the current Curtain Color state.

### ■ Splash Screen

Use this row to set the splash screen on each individual panel ON or OFF.

### ■ Freeze Input

Use this row to turn the freeze input function on each individual panel ON or OFF.

6. Disable **Monochrome mode**.

7. Enable **Blue Check Field mode** and adjust the **Color** button so that the outermost bars (white and blue) appear to match in brightness.

8. Composite NTSC only: Adjust the **Tint** button until the third bar from the left (cyan) and the third bar from the right (magenta) appear to match in brightness.

9. Disable **Blue Check Field mode**.

### ■ Ratio Settings

Use to switch between 4:3 and 16:9 aspect ratios.

- In 4:3 mode, images are scaled to fill the center 4:3 portion of the screen. With a 16:9 source, images will be centered with a black letter-box added on the left and right sides.
- In 16:9 mode, images are scaled to a 16:9 portion of the screen, with a black letter-box added top and bottom.

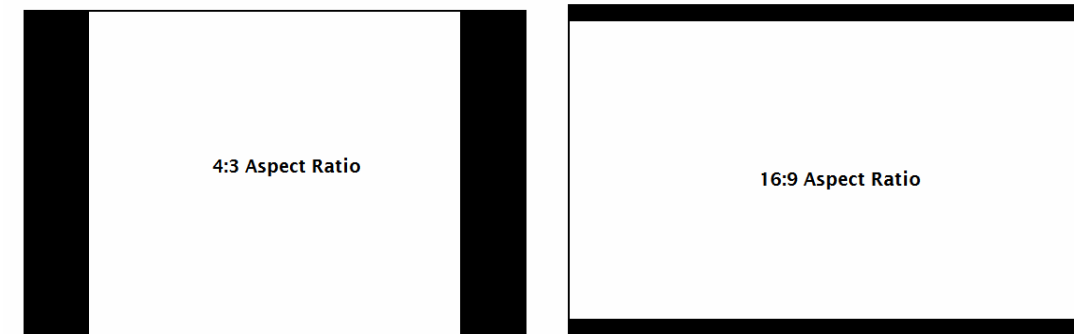

Note: The aspect ratio setting is ignored when Pixel-to-Pixel mode is enabled.

### ■ Pixel-to-Pixel

Use this setting to enable Pixel-to-Pixel mode.

This Pixel-to-Pixel mode bypasses the monitor's internal scaling function and displays incoming images in their native resolution and aspect ratio, with a one-to-one mapping:

- For incoming formats smaller than the native resolution of the LCD panel, the image will be displayed in the center of the screen using only the necessary LCD pixels. For example, NTSC images will occupy exactly 720 x 480 pixels. The surrounding pixels will be black.

Note: Pixel-to-Pixel mode disables aspect ratio control and H/V Delay.

## MARKER CONFIGURATION SUBMENU

Use the Video Configuration submenu to select various video settings such as monochrome mode or blue-only mode.

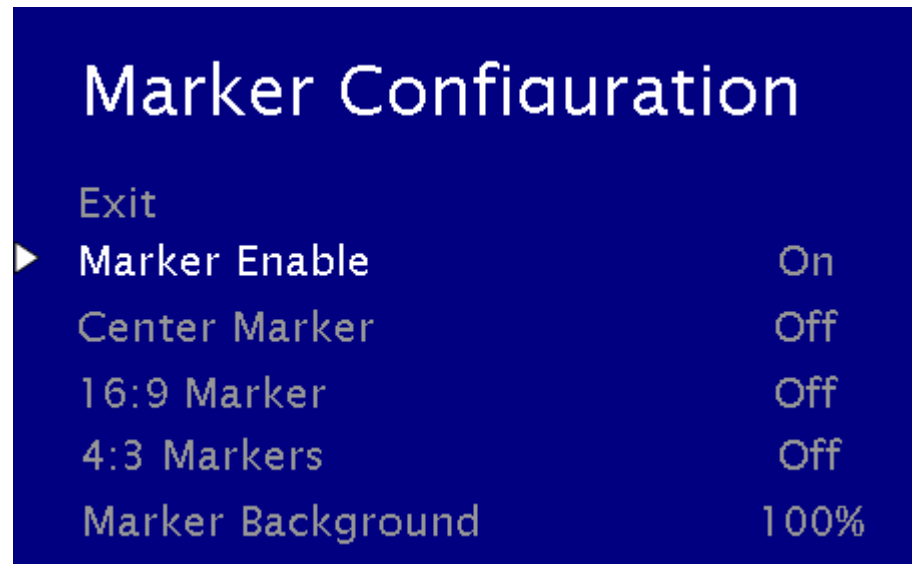

Marker Configuration Submenu

■ **Marker Enable**

Use this setting to enable or disable all on-screen markers. This setting affects the center marker, full screen markers, 16:9 markers and 4:3 markers.

■ **Center Marker**

Use this setting to display a center marker on the screen.

■ **16:9 Markers**

Use these settings to superimpose one of 12 markers on the screen when in 16:9 mode.

- 4:3
- 13:9
- 14:9
- 1.85:1
- 2.35:1
- 95% Safe
- 93% Safe
- 90%Safe
- 88% Safe
- 85% Safe
- 80% Safe

**16:9 Marker Examples:**

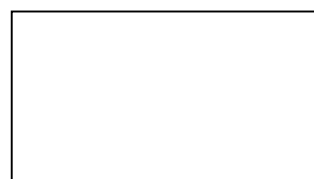

OFF (No Marker)

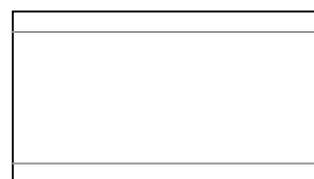

2.35:1 Aspect Ratio

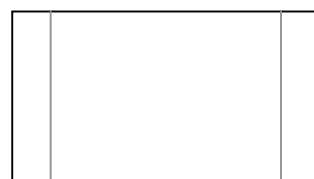

4:3 Aspect Ratio Marker

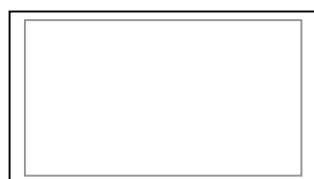

90% Safe Area

## Network Control Page

This MD Series monitor allows you to fully control all settings via a Lan100 Ethernet port on the rear of the monitor. Simply connect the MD Series monitor to your network with an Ethernet patch cable and access the monitor's Host Name or IP Address via the web browser on your computer and take control.

*\*We recommend Mozilla Firefox v7.0 and above for the best experience*

Note: The Network Control page is designed to be consistent throughout the entire MD Series. As such, some commands on the Network Control page may not be available for all monitors. Please use the on screen menu to verify which functions will be operational and which ones will not.

### Power Tab

#### Power / Input Page

■ **Power**

Use this row to determine the Power status for each of the screens on the unit. A green ON box indicates that the screen is currently on. A red OFF box indicates that the unit is off. Press the box to toggle the screen ON or OFF.

■ **Input**

The input field allows you to identify the module type currently in your monitor's slot.

■ **Format**

This text field determines the input format currently being displayed on a particular monitor screen. A No Signal string indicates that there is no signal present.

### Menu Tab

#### Video Config

■ **Color Temperature**

Use this row to set the current Color Temperature preset being used on the screen.

■ **Gamma**

Use this row to set the current Gamma preset being used on each screen.

■ **RGB Bias and Gain**

Click the Adjust button in this row to move into the RGB Bias and Gain controls. This is covered in depth in previous sections of this manual, in the Image Adjust submenu.

■ **Check Field**

Use this row to set the current Check Field mode being used on an individual screen.

### ■ Remote Enable

Use this setting to allow the monitor to be controlled by other monitors on a V-MD Network. Choose Global to allow access from any monitor or choose Own Webpage Only to only allow the monitor's web page to control the monitor.

### ■ Configuration Mode

Use this setting to choose between a DHCP IP address retrieval and Manual IP address selection.

### ■ IP Address

When using a Manual Configuration Mode, use this field to assign a specific IP address for your monitor. When in DHCP Configuration Mode, this field will automatically be filled by the IP address assigned by your network.

### ■ Subnet Mask

When using a Manual Configuration Mode, use this field to assign a specific Subnet Mask for your monitor. When in DHCP Configuration Mode, this field will automatically be filled by the Subnet Mask assigned by your network.

### ■ Default Gateway

When using a Manual Configuration Mode, use this field to assign a specific Default Gateway for your monitor. When in DHCP Configuration Mode, this field will automatically be filled by the Default Gateway assigned by your network.

### ■ Host Name

Use this field to enter a Host Name for your monitor. You may choose up to 16 alphanumeric characters for the host name.

### ■ Web Authentication

Use this field to turn Web Authentication ON or OFF. If turned on, you will be asked to select a Username and Password in the subsequent fields.

**Username:** 15 Alphanumeric character string

**Password:** 15 Alphanumeric character string

### ■ MAC Address

This field will show the MAC address associated with the particular monitor in question.

### ■ 4:3 Markers

Use this setting to superimpose one of 5 markers on the screen when in 4:3 mode.

- 95% Safe Area
- 93% Safe Area
- 90% Safe Area
- 88% Safe Area
- 85% Safe Area
- 80% Safe Area

#### 4:3 Marker Examples:



OFF (No Marker)

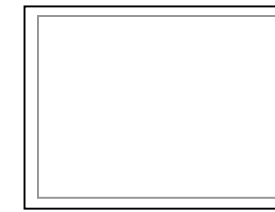

90% Safe Area

### ■ Marker Background

Use this setting to choose how selected markers are displayed on the screen. :

- 0% The marker is superimposed on the complete image.
- 25% Image area beyond the marker is shown at 25% intensity.
- 50% Image area beyond the marker is shown at 50% intensity.
- 75% Image area beyond the marker is shown at 75% intensity.
- 100% Image area beyond the marker is shown at 100% intensity (black).

#### Example (80% Marker in 4:3 Mode):

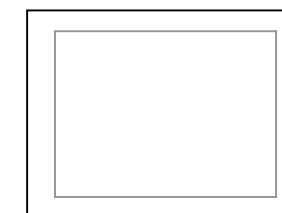

0% Background

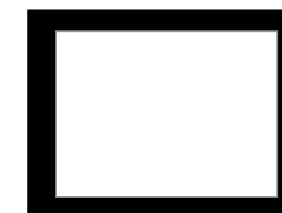

100% Background

## FILTER CONFIGURATION SUBMENU

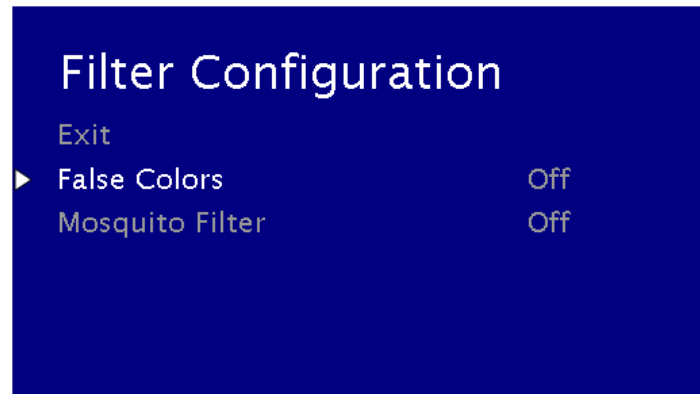

### False Colors

This monitor has a false color filter to aid in the setting of camera exposure. As the camera Iris is adjusted, elements of the image will change color based on the luminance or brightness values. This enables proper exposure to be achieved without the use of costly, complicated external equipment. To best utilize this feature, you must understand the color chart below and have a basic understanding of camera exposure. Normally, when shooting subjects like people, it is common practice to set exposure of faces to the equivalent of approximately 56 IRE. The false color filter will show this area as the color PINK on the monitor. Therefore, as you increase exposure (open the IRIS), your subject will change color as indicated on the chart: PINK, then GREY, then a few shades of YELLOW. Over exposed subjects (above 101 IRE) on the monitor will be shown as RED. In addition, underexposed subjects will show as DEEP-BLUE to DARK-BLUE, with clipped-blacks indicated with a FUCHSIA-like color. Lastly, the color GREEN is used to indicate elements of the image that are approximately 45 IRE. This represents a 'neutral' or 'mid-level' exposure commonly used for objects (not people).

### On-Screen Tally

Use the On-Screen Tally option to turn the On-Screen tally ON or OFF.

### Text Tally

Use the Text Tally option to lock the Text String color to the same color as the current Tally color. When there is no specific tally color enabled, the text string will default to the Text Color selection made in the IMD & Tally Configuration menu option.

## SYSTEM INFORMATION SUBMENU

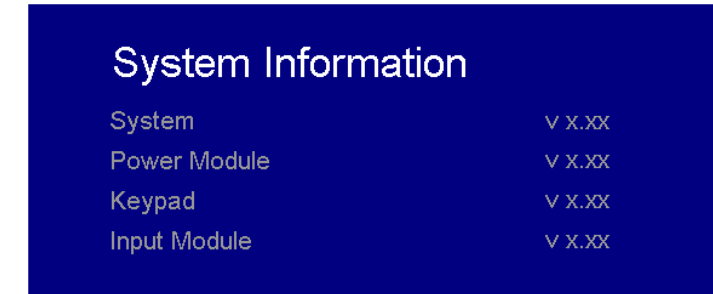

### System

This shows the System firmware version of your monitor.

### Power Module

This shows the Power Module firmware version of your monitor.

### Keypad

This shows the Keypad firmware version of your monitor.

### Input Module (1 or 2)

This shows your module type and the firmware version of your module. If no module is present, the word EMPTY will appear in parentheses.

## NETWORK CONFIGURATION SUBMENU

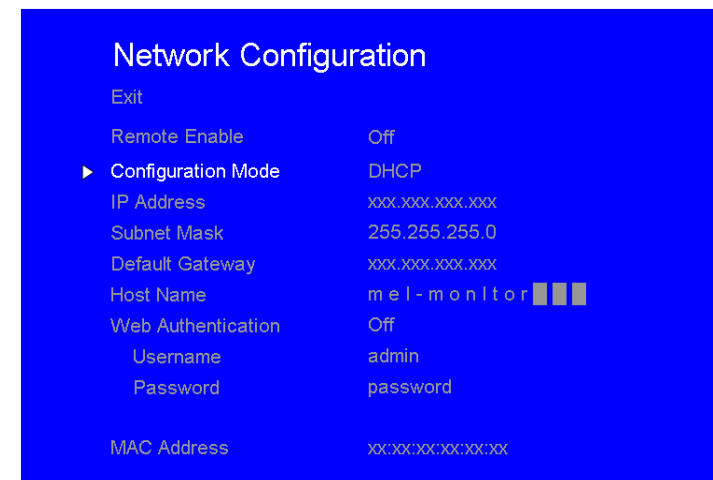



## IMD & TALLY CONFIGURATION

IMD & Tally Configuration	
Exit	
▶ Text Enable	Off
Text String	Marshall Monitor
Text Color	Green
Text Background	50%
Text Alignment	Center
Tally Source	HD-15 (Contact Closure)
LED Tally	On
On-Screen Tally	Off
Text Tally	Off

### ■ Text Enable

Use the Text Enable function to turn the MD Text feature ON. This will cause the Text String to appear on the lower portion of the screen.

### ■ Text String

Use this field to enter your own 16 character string on the screen.

### ■ Text Color

Use this field to change the color of the text in the Text String field.

### ■ Text Background

Use this field to change the opacity of the background behind the text in the Text String field. A value of 0% will cause the background to appear black. A value of 100% will make the background invisible.

### ■ Text Alignment

Use this field to change the alignment of the text string mentioned above.

### ■ Tally Source

Use this setting to change the source of the LED tally lights. Choosing the HD-15 (Contact Closure) option will render the LAN Tally interface disabled. Choosing the LAN 100 option will also render the HD-15 (Contact Closure) connector inoperable.

### ■ LED Tally

Use the LED Tally option to turn the physical LED tally lights ON or OFF.

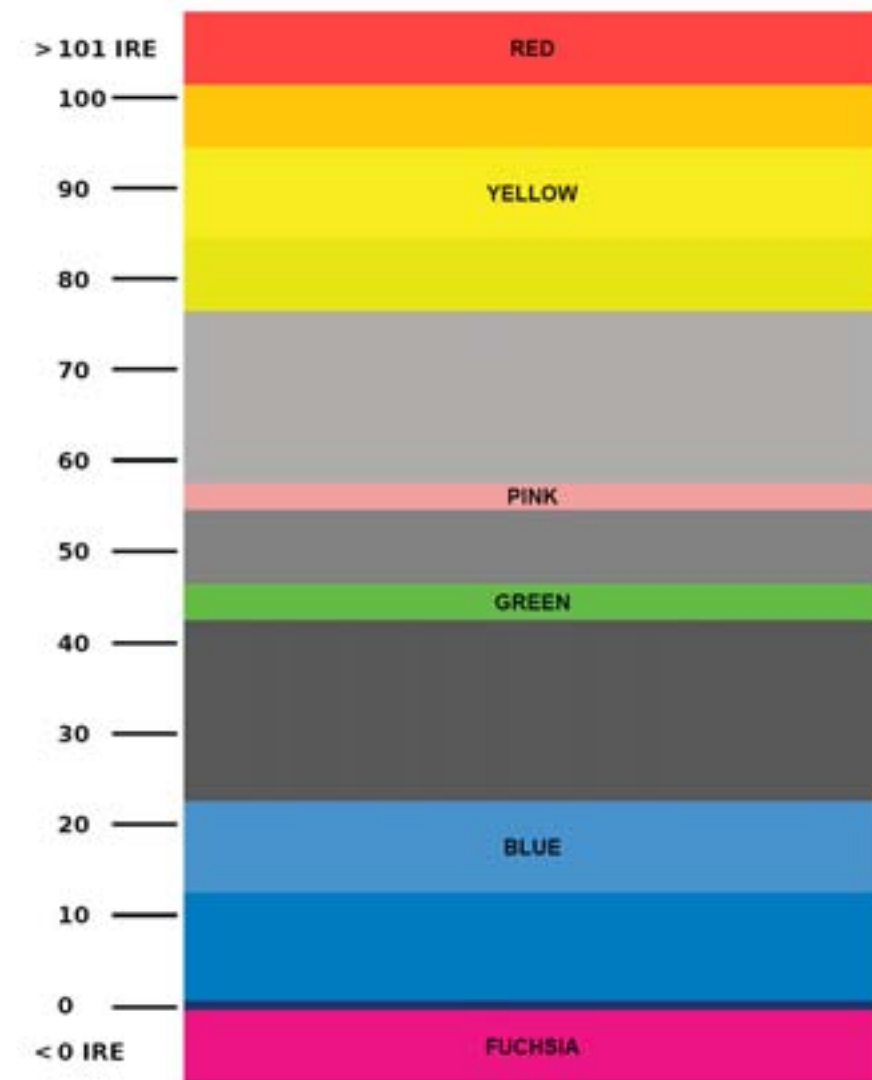

False Color Key

## ■ Mosquito Filter

Use this setting to filter out “Mosquito Noise” – an artifact that appears as specs around edges of objects. This artifact is the result of video that has been compressed at some point. Video sources from DVD-Players, PDA’s, Digital Cable Boxes, Camcorders, etc. often have this artifact.

## SYSTEM CONFIGURATION SUBMENU

Use the Color Configuration submenu to adjust the color temperature of the display.

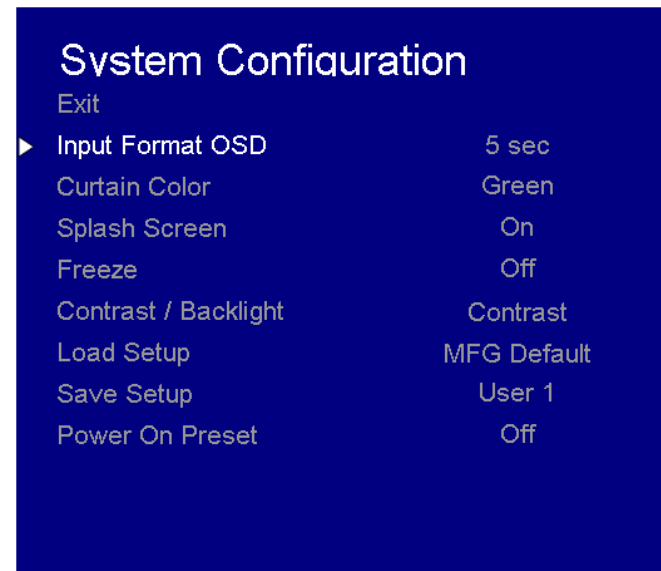

Color Configuration Submenu

## ■ Input Format OSD

Use this option to enable on-screen display of input/format status in the upper-left corner of the screen.

## ■ Curtain Color

Use this option to change the curtain color on the monitor. This curtain color is what you see when there is no signal input to the monitor.

## ■ Splash Screen

Use this option to enable or disable the Marshall Electronics Inc. splash screen seen when the monitor is first powered on.

## ■ Freeze

Use the Freeze function to “freeze” the current image on the screen. Select this menu item again (Unfreeze) to return to the real-time video input.

## ■ Contrast / Backlight

*This feature is not applicable to the V-MD185 monitor.*

## ■ Load Setup

Select this menu item to reset all adjustments and menu settings to the factory default configuration or to one of the user configured presets.

## ■ Save Setup

Select this menu item to save a current setup into one of 6 available user presets.

## ■ Power On Preset

Select this menu item to reset all adjustments and menu settings to the factory default configuration whenever the unit is powered down.

## FUNCTION PRESETS SUBMENU

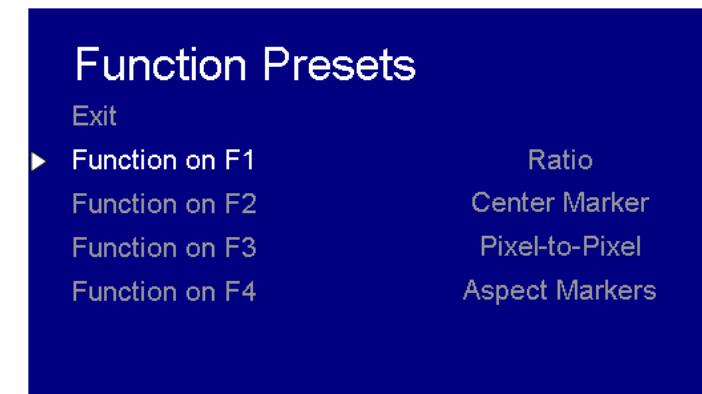

## ■ Function Presets

Allows user to assign menu items to the front panel function buttons: **F1, F2, F3 and F4**. The following options are available for each button:

- Ratio
- Check Field
- Mosquito Filter
- False Colors
- Freeze Input
- Aspect Markers
- Center Marker
- Marker Enable
- Pixel-to-Pixel